

XPOW-AX-PST

SPECIFICATION SHEET AND MANUAL
2025



Version: 6.7

Date: 24 February 2025

Important Notice and Disclaimer:

No part of this document may be reproduced in any form or by any means (including electronic storage and retrieval or translation into a foreign language) without prior agreement written consent from Nicslab. No responsibility is assumed by Nicslab for its use, nor for any infringements of patents or other rights of third parties that may result from its use. Trademarks and registered trademarks are the property of their respective owners.

This product is designated for skilled user. You are entirely responsible for (1) choosing the appropriate Nicslab products for your operation, (2) designing, validating and testing your operation, (3) ensuring your operation meets applicable standards, and any other safety, security or other requirements.

This documentation is protected by copyright ©. All rights reserved.

Safety Note

Do not operate this product in any manner not specified by Nicslab. Failure to comply with these precautions or with specific warnings or instructions elsewhere in this manual violates safety standards of design, manufacture, and intended use of the instrument. Nicslab assumes no responsibility for any damage caused by mishandling that is beyond normal usage defined in this manual of this product.

Warning

Dangerous voltages capable of causing injury or death, are present in this instrument.

Caution

This symbol indicates hazard of any operating procedure, practice, or the like that, if not correctly performed or adhered to, could result in damage to the product or loss of important data.

Line Fuse

Fuse size is $\varnothing 5 \times 20$ mm. For 220V/250V, there are two 3A fuses.

Line Cord

The XPOW-AX-PST has a detachable, three-wire power cord for connection to the power source and to a protective ground.

Do Not Discard the Instrument Cover

Only authorized personnel from Nicslab should remove the instrument cover. Do not remove the covers while the unit is plugged into a live outlet

Do Not Alter the Instrument

Do not put any unauthorized parts or modify the instrument without Nicslab approval and warranty.

Cleaning Steps

To clean the instrument exterior:

- Unplug instrument from all voltage sources.
- Remove loose dust on the outside of the instrument with a barely damp lint-free cloth.
- Do not use abrasive cleaners.
- Allow the instrument to dry before reconnecting the power cord.

Contents

| | |
|---|----|
| List of Tables | 4 |
| List of Figures | 4 |
| 1. Introduction | 5 |
| 2. Hardware | 7 |
| Specification Conditions | 7 |
| Hardware Requirement | 7 |
| Box Descriptions | 8 |
| XPOW-AX-PST Specifications | 11 |
| 3. Getting Started | 12 |
| Hardware Installation | 12 |
| Electrode Installation | 16 |
| 4. Software and Graphical User Interface (GUI) | 18 |
| Software Feature | 18 |
| Software Requirement | 18 |
| Software Installation | 18 |
| How to Detect Which COM is Used (Optional) | 19 |
| Graphical User Interface (GUI) | 19 |
| Initializing the GUI | 21 |
| Open Circuit Potential | 25 |
| Single Point | 27 |
| Linear Sweep Voltammetry | 28 |
| Cyclic Voltammetry | 29 |
| Electrochemical Impedance Spectroscopy | 30 |
| Linear Polarization Resistance | 32 |
| Potentiodynamic Polarization (PDP) | 33 |
| Voltage & Current Range | 34 |
| Corrosion Rate via Linear Polarization Resistance | 35 |
| Corrosion Rate via Potentiodynamic Polarization (Tafel Extrapolation) | 39 |
| Output Data | 44 |
| Custom Line Settings | 44 |
| Graphic Chart Options | 45 |
| Axis Chart Options | 50 |

| | | |
|----|-------------------------------|----|
| | Help | 50 |
| | Check Version | 51 |
| | GUI Reset | 51 |
| | File Settings | 51 |
| 5. | System Shutdown | 55 |
| 6. | Troubleshooting | 56 |
| 7. | Warranty | 57 |
| 8. | Contact | 57 |

List of Tables

| | | |
|----------|---------------------------|----|
| Table 1. | Checklist Items | 6 |
| Table 2. | Specification Conditions | 7 |
| Table 3. | Performance Specification | 11 |
| Table 4. | Voltage & Current Range | 34 |
| Table 5. | Troubleshooting | 56 |

List of Figures

| | | |
|-----------|--|----|
| Figure 1 | XPOW-AX-PST System Diagram | 5 |
| Figure 2. | Schematic of XPOW-AX-PST into electrode cell | 6 |
| Figure 3. | Product Dimension | 8 |
| Figure 4. | Front and Back Panel | 9 |
| Figure 5. | Electrode Color Code | 16 |
| Figure 6. | Two Electrodes Cell Setup | 16 |
| Figure 7. | Three Electrodes Cell Setup | 17 |
| Figure 8. | Four Electrodes Cell Setup | 17 |
| Figure 9. | GUI | 20 |

1. Introduction

The XPOW-AX-PST is a single channel potentiostat/galvanostat for an electrochemical measurement system that can perform a variety of methods such as: Linear Sweep Voltammetry (LSV), Cyclic Voltammetry, Square Wave Voltammetry (SWV) and Electrochemical Impedance Spectroscopy (EIS). XPOW-AX-PST is equipped with 4 probes that allow connection to 2, 3, and 4 electrode systems. The XPOW-AX-PST provides 1 (one) channel controlled by Graphical User Interface (GUI) via Universal Serial Bus (USB) port.

The features of XPOW-AX-PST in details are:

- One channel with 4 electrode connection (WE, RE, CE, SE) that can be daisy chained according to the number of channels needed.
- 12 V compliance, 12 W (standby mode) and 1 A output capability
- Intuitive GUI
- Durable hardware
- Record data
- Short circuits protection
- USB port with USB line termination, filtering and ESD protection
- Windows, MacOS and Linux support
- Compliance with IEC61000-4-2 ESD Protection for USB Port

The XPOW-AX-PST is connected to AC power via a wall socket, then the electrode cell setup can be connected to the XPOW via 4 cables with distinctive colors representing different electrodes. The system diagram is as follows:

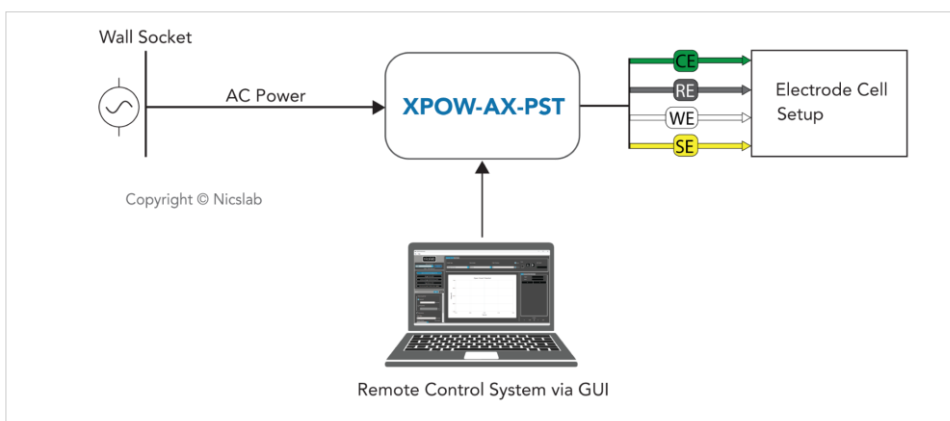

Figure 1 XPOW-AX-PST System Diagram

Here is a simplified Schematic of XPOW-AX-PST with a connection to the three Electrode Cell Setup:

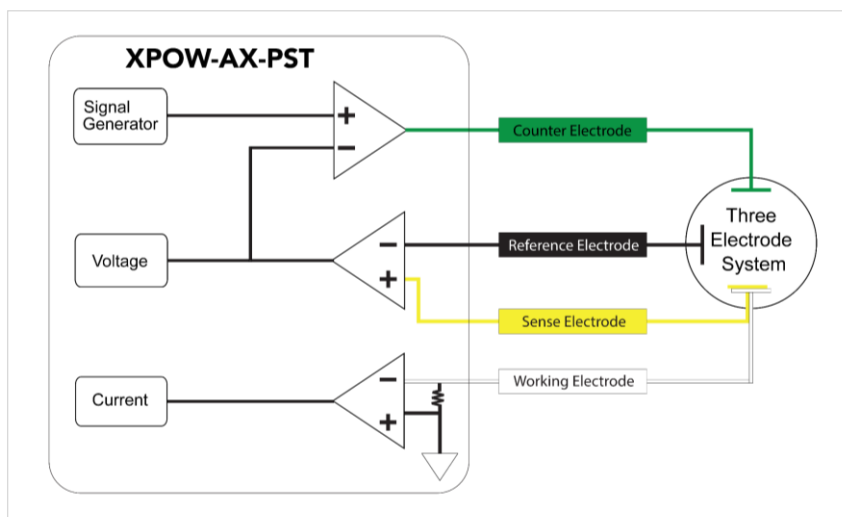

Figure 2. Schematic of XPOW-AX-PST into electrode cell

There are 4 (four) different electrodes: Working Electrode (WE), Counter Electrode (CE), Reference Electrode (CE), and Sense Electrode (SE). Figure 2 shows the connection for the potentiostat, we can see that for three electrode system, the SE port is coupled with the WE port.

The potentiostat will control the potential at WE with respect to the CE, along with the Signal Generator. The counter electrode will complete the cell circuit to allow current flow in the cell. Potential and Current of the WE will be measured and sent to the Graphical User Interface (GUI).

The package should include the following items:

Table 1. Checklist Items

| No | Item | Qty (pc) | Checklist |
|----|---|----------|-----------|
| 1 | XPOW-AX-PST Box | 1 | |
| 2 | AC power line cord | 1 | |
| 3 | USB 3.0 cable type Mini A | 3 | |
| 4 | CE, RE, SE, & WE cable | 1 | |
| 5 | USB flash disk | 1 | |
| 6 | Inside the USB flash disk: a. GUI b. Specification & Manual c. Test Report | 1 | |

2. Hardware

Specification Conditions

The operating and measurement conditions are under the following conditions:

Table 2. Specification Conditions

| Items | Conditions |
|----------------------|--|
| Room Temperature | 0 ~ 40 °C |
| Humidity | 5 ~ 80 % (no condensing) |
| AC Power Input | AC Input 220 V with Voltage Range 90 to 264 VAC. Frequency 47 to 63 Hz. |
| Waterproof/Dustproof | To be operated under room condition |
| Calibration period | 2 years |

Hardware Requirement

The requirements for the PC/laptop to be used for this product installation are:

- Resolution Min. 1024 x 768 pixel
- Hard disk Min. 500 MB of available free space (32-bit and 64-bit operating system)
- USB Port USB 2.0
- RAM Min. 2 GB
- CPU 2.4 GHz or faster

Box Descriptions

The box size is 232 (W) x 450 (L) x 102 (H) mm, as illustrated in the pictures below:

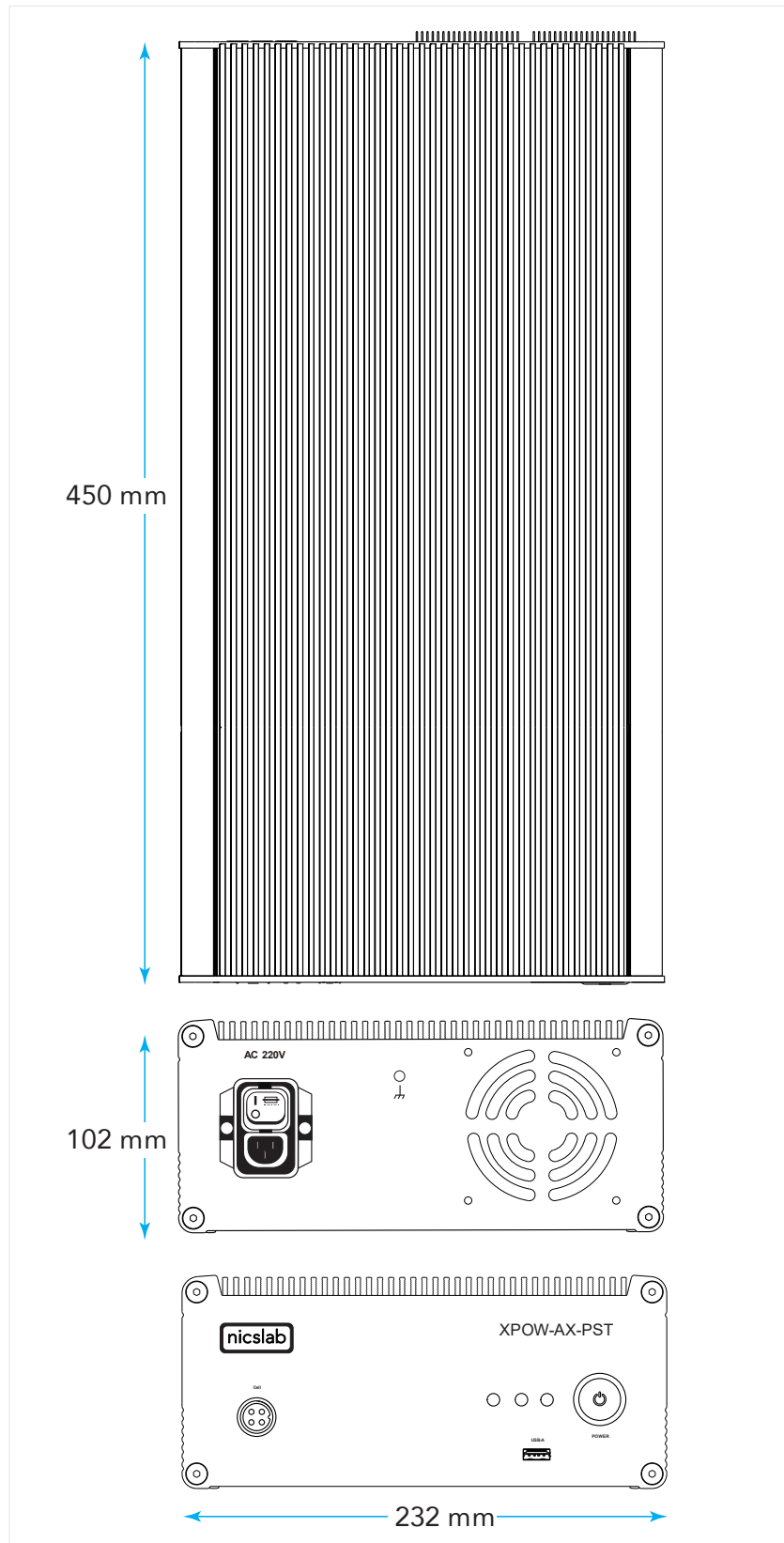

Figure 3. Product Dimension

The details of the front and back panels of the box are described below:

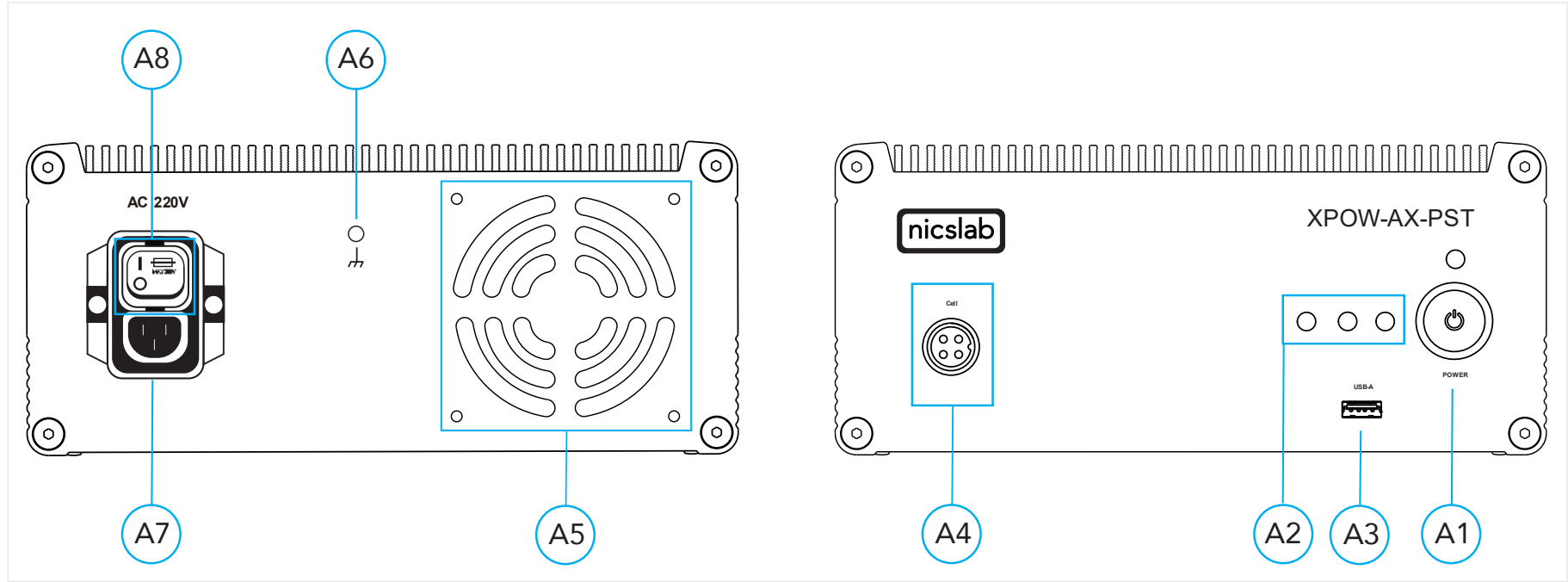

Figure 4. Front and Back Panel

Note:

| | | |
|----|---------------------|--|
| A1 | DC Power Button | To turn the instrument on or off. Caution Before turning OFF please close the GUI to minimize the risk of corrupting the system file (such as data loss). |
| A2 | Indicator Lights | Right -> Green = The hardware is On. Middle -> Blue = Program Ready Indicator. Left -> Red = Measurement is ongoing. |
| A3 | USB-A | USB type A minimum version 2.0. |
| A4 | Output Channel | Connect to the electrodes with maximum output voltage is 12 V and 1 A. |
| A5 | Airflow | For air circulation inside the box. |
| A6 | Ground | Act as a Ground (GND) for safety. |
| A7 | Power Cord AC 220 V | Caution To input AC power to the instrument. Please follow the safety notice on your electricity input. |
| A8 | AC Power Switch | Switch to turn the power on or off |

XPOW-AX-PST Specifications

The performance specifications are listed in the Table 3 below:

Table 3. Performance Specification

| No | Parameter | Min | Typ | Max | Unit | Test conditions/ comments | | | |
|----|------------------------------|-------------|--------------|-------|---------|------------------------------|------------|---------|------------------------------|
| 1 | DAC Resolution | | 16 | | Bits | | | | |
| 2 | Potential Control Range | -10 | | +10 | V | | | | |
| 3 | Potential Control Resolution | | 305.17578225 | | μ V | | | | |
| 4 | Settling Time | | 0.6 μ | | s | 10 V step | | | |
| 5 | CV and LSV Scan Rate | 0.001m | | 10000 | V/s | | | | |
| 6 | ADC Resolution | | 12 | | Bits | | | | |
| 7 | Sampling Rate | | | 1 | MHz | | | | |
| 8 | Frequency Sweep Range | 10m | | 100k | Hz | | | | |
| 9 | AC signal Amplitude | 75 | | 5000 | mV | | | | |
| 10 | DC bias | -10 | | +10 | V | | | | |
| No | Parameter | Range/Types | | | | | | Unit | Test conditions/ comments |
| 11 | Electrode System | 2 | 3 | 4 | | | Electrodes | 3 Types | |
| 12 | Reading Range – Current | 10 μ | 100 μ | 1m | 10m | 100m | 1 | A | 6 Ranges |
| 13 | Reading Range - Voltage | 500m | 1 | 5 | 10 | | | V | 4 Ranges |

3. Getting Started

Hardware Installation

This section describes how to configure the XPOW-AX-PST. Make sure you follow the instruction step by step. The instruction must follow in order. The Step are as Follows:

Warning

Plug the provided AC cable cord to the electricity socket. Do not replace the detachable mains supply cords with inadequately rated cords. Failure to use properly rated cords may result in personal injury or death due to electric shock.

To connect the AC power:

1. Plug the 3P into Wall Socket (220 V) and make sure that the AC Power Switch (A8) is the off (O) position.

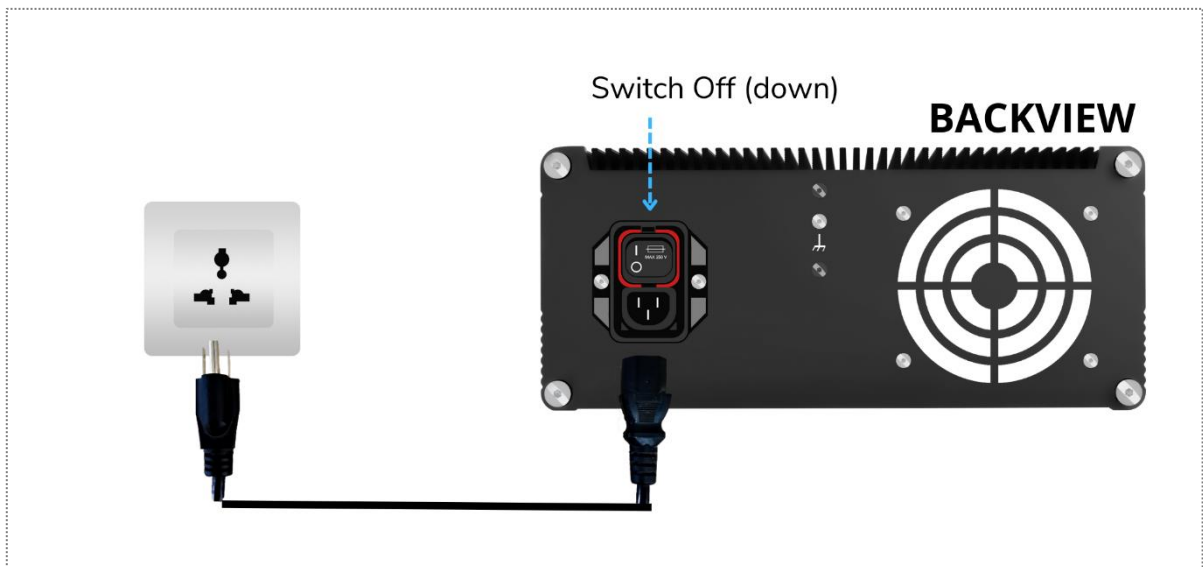

2. Turn the AC Power Switch on (I)

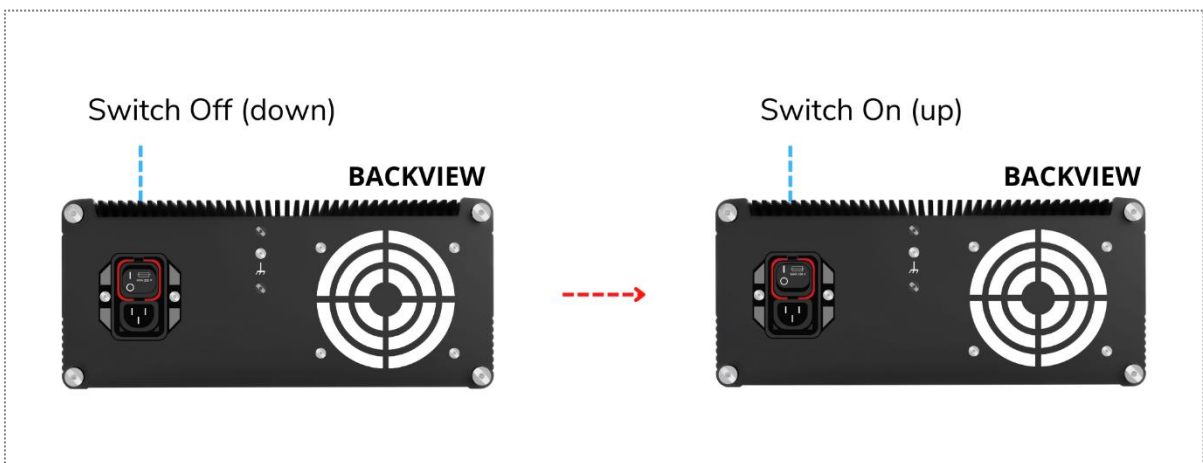

To turn the instrument on or off:

3. Before turning the instrument on, disconnect any device under tests (DUTs) from the instrument.
4. To turn your instrument on, push the front-panel DC power button (A1). Push the DC Power button until the blue light on the button is on.



5. Wait for the hardware light indicator (right LED) to turn **Blue**.



6. Connect XPOW-AX-PST into your Workstation via USB-A

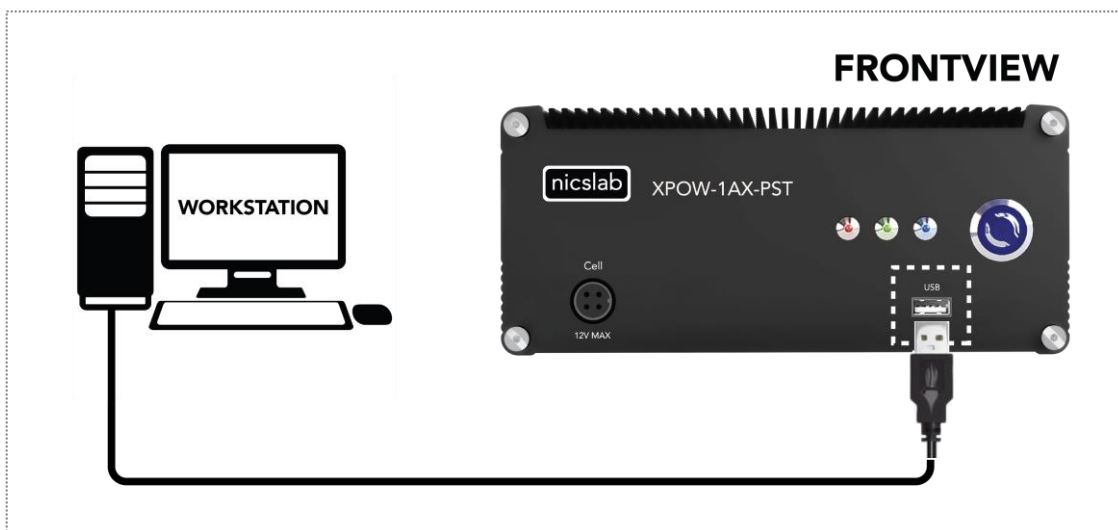

7. Connect XPOW-AX-PST into your electrochemical cell via DB-4P (to XPOW-AX-PST) and crocodile clip (to electrochemical cell). You can now open the Graphical User Interface (GUI) to control the device.

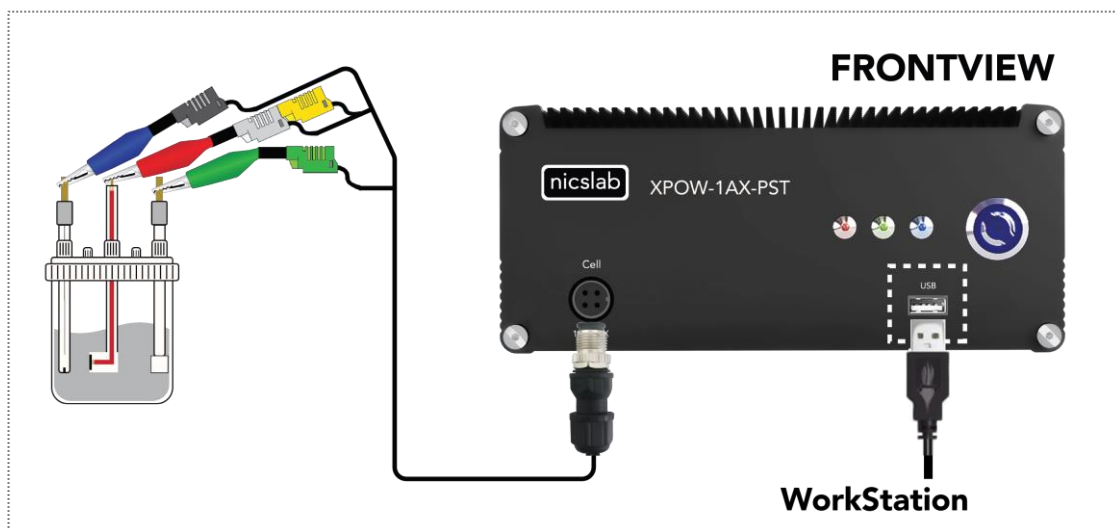

8. Connect the GUI to the device by clicking connect button. The middle LED will turn **Green** to indicate the hardware is connected to the GUI and on standby.

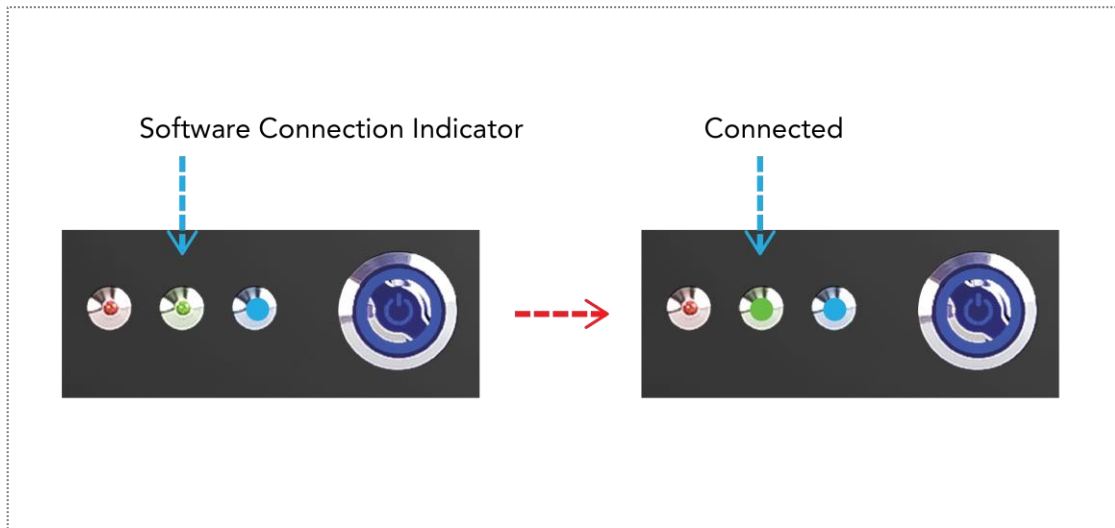

9. When you start the measurement, the left side LED on the device will turn **Red** to indicate the measurement is ongoing, after the measurement is finished / stopped, the light will turn off.

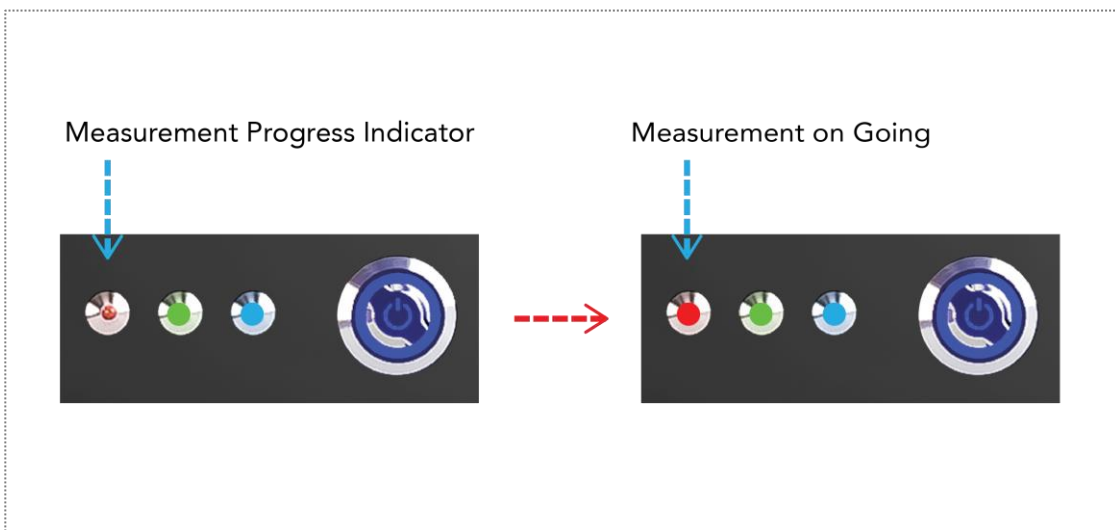

10. To turn your instrument off, make sure to do it after the GUI is closed. First push the DC power button (A1). Push the DC Power button until the light on it is off. The LEDs will be turned off too.

11. Turn off the AC Power Switch (A8) by flicking the switch down (O) position, then unplug the 3P from the Wall Socket (220 V).

Electrode Installation

This section describes how to configure the Electrode cells before you connect it to XPOW-AX-PST. You need to use all four of the electrodes (CE, RE, SE, and WE) to optimize the instrument. Make sure to have these things before you start:

- Sealed electrolytic cell.
- Counter Electrode.
- Reference Electrode.
- Sense Electrode.
- Working Electrode.
- Cables with alligator clip or banana plug (depends on the electrode).

This is the color code that used on our proprietary cable:

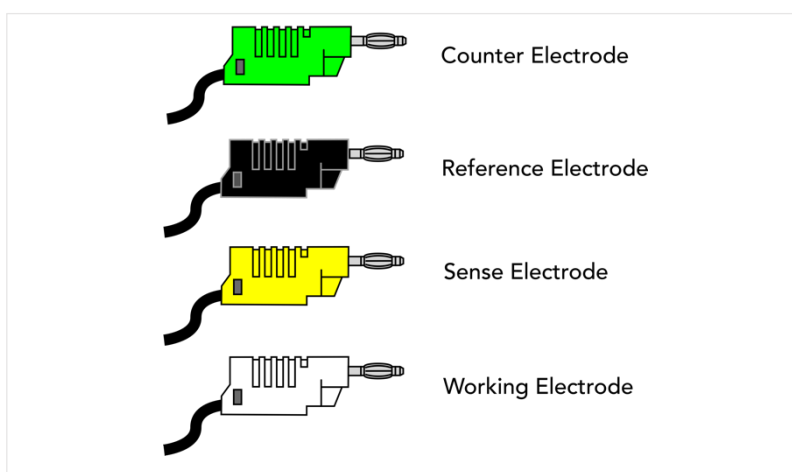

Figure 5. Electrode Color Code

Determine which setup types do you want to use. The most common setup is 3 (three) electrodes setup. Other types are 2 (two) electrodes and 4 (four) electrodes setup.

Here is a simple schematic of 2 (two) electrodes setup:

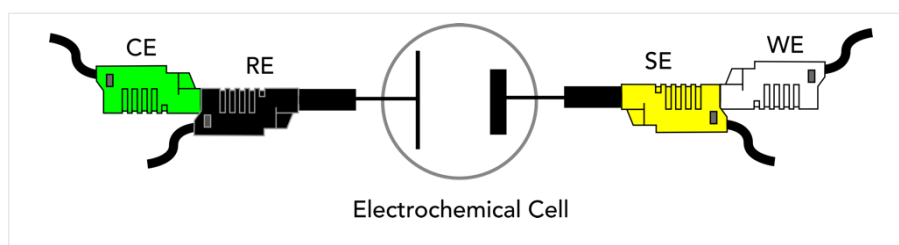

Figure 6. Two Electrodes Cell Setup

The two electrodes setup is suitable for measurements that do not require precise control, or where measurement of the whole cell voltage is significant. It is usually used in energy storage or conversion devices experiments like batteries, fuel cells, and photovoltaic panels. It is also used in electrochemical

impedance measurement. We can see that SE port is coupled with WE port, and RE port is coupled with CE port.

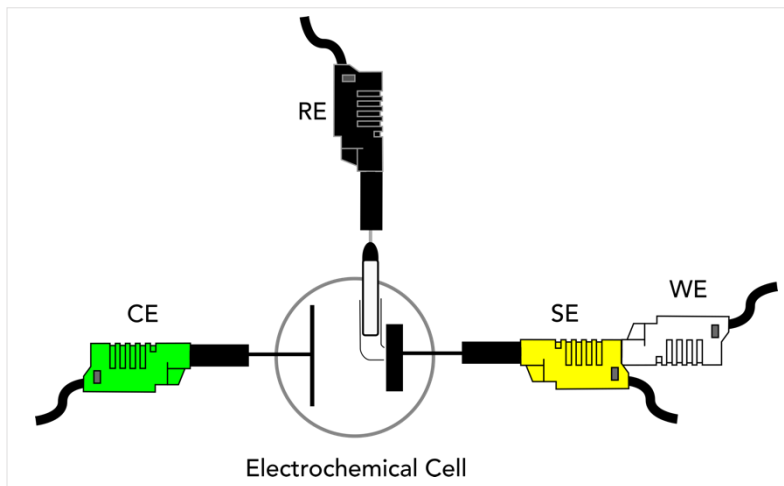

Figure 7. Three Electrodes Cell Setup

In Figure 7, we can see that RE port is separated from other electrodes, and placed near the SE. This allows for more precise measurements of potential and current since the potential changes of the WE are measured independently of changes that may occur at the CE.

Simple schematic with four electrodes cell:

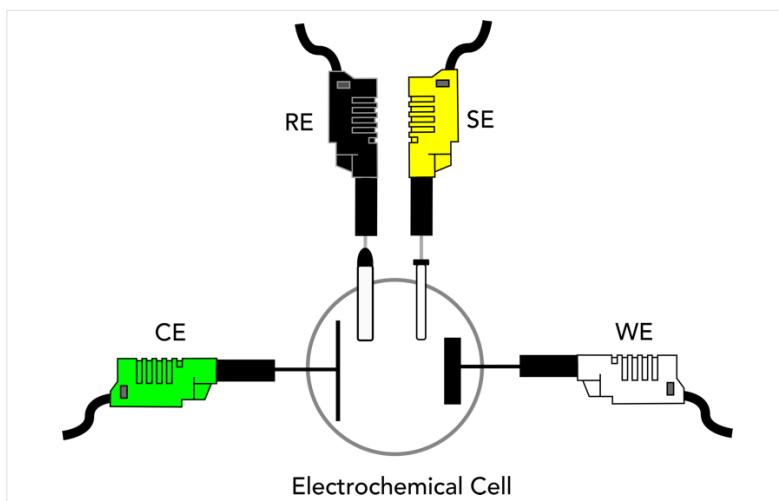

Figure 8. Four Electrodes Cell Setup

The four electrodes cell setup is rarely used in electrochemistry. In Figure 8, we can see that every electrode is independent of each other, and the potentials for any electrochemical reactions at WE and CE electrodes are not being measured. It measures the effect of an applied current on the solution itself (or some barrier in that solution).

4. Software and Graphical User Interface (GUI)

Software Feature

The XPOW-AX-PST's software creates plot for Open Circuit Polarization, Single Point (Potentiostatic), Linear Sweep Voltammetry, Cyclic Voltammetry, Electrochemical Impedance Spectroscopy, Linear Polarization Resistance, and Potentiodynamic Polarization measurements. The software can also create plotting for non-linear fitting on Butler-Volmer equation of polarization curve. It can calculate Tafel slope, corrosion current density, limitation current, polarization resistance, corrosion rate, and power spectrum density, noise resistance and noise spectrum resistance.

Software Requirement

The GUI software is suitable with the following operating systems:

- Windows® 10 (64-bit).
- Windows® 11 (64-bit).
- macOS 11 Big Sur.

Software Installation

The first step is to copy the GUI installation file into your hard disk. For Mac, you can directly copy the GUI folder to the 'Application' folder.

1. Double click the icon below to install the GUI. If a prompt appears, click yes.



2. Check the 'Create a desktop shortcut' checkbox, then click next and Install.

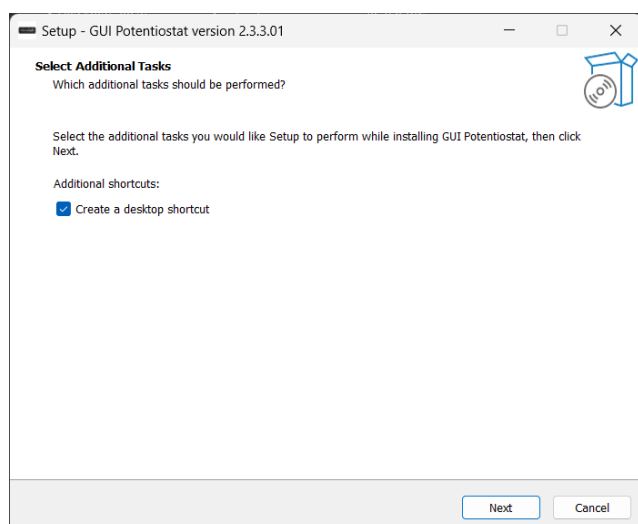

3. After installation finished, double click the executable GUI icon (as shown below) on your desktop to launch the GUI.



How to Detect Which COM is Used (Optional)

This step is valid when using earlier version of the GUI, which have Com Port selection when connecting to the device. **Newer Device and GUI does not require these steps.** This also can only be done in **Windows Operating System.**

1. Click **Start**  Type "Device Manager", and then click **Device Manager**.

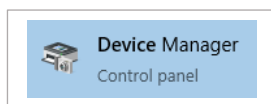

2. Find **Ports (COM & LPT)**.

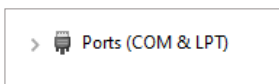

3. When XPOW connects on the computer, there are 3 (three) Arduino Leonardo ports detected with COM number as shown below.

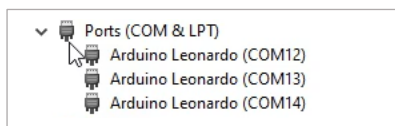

Graphical User Interface (GUI)

Start the XPOW by pressing the ON button, then you can control it by GUI. The display details are on the next page.

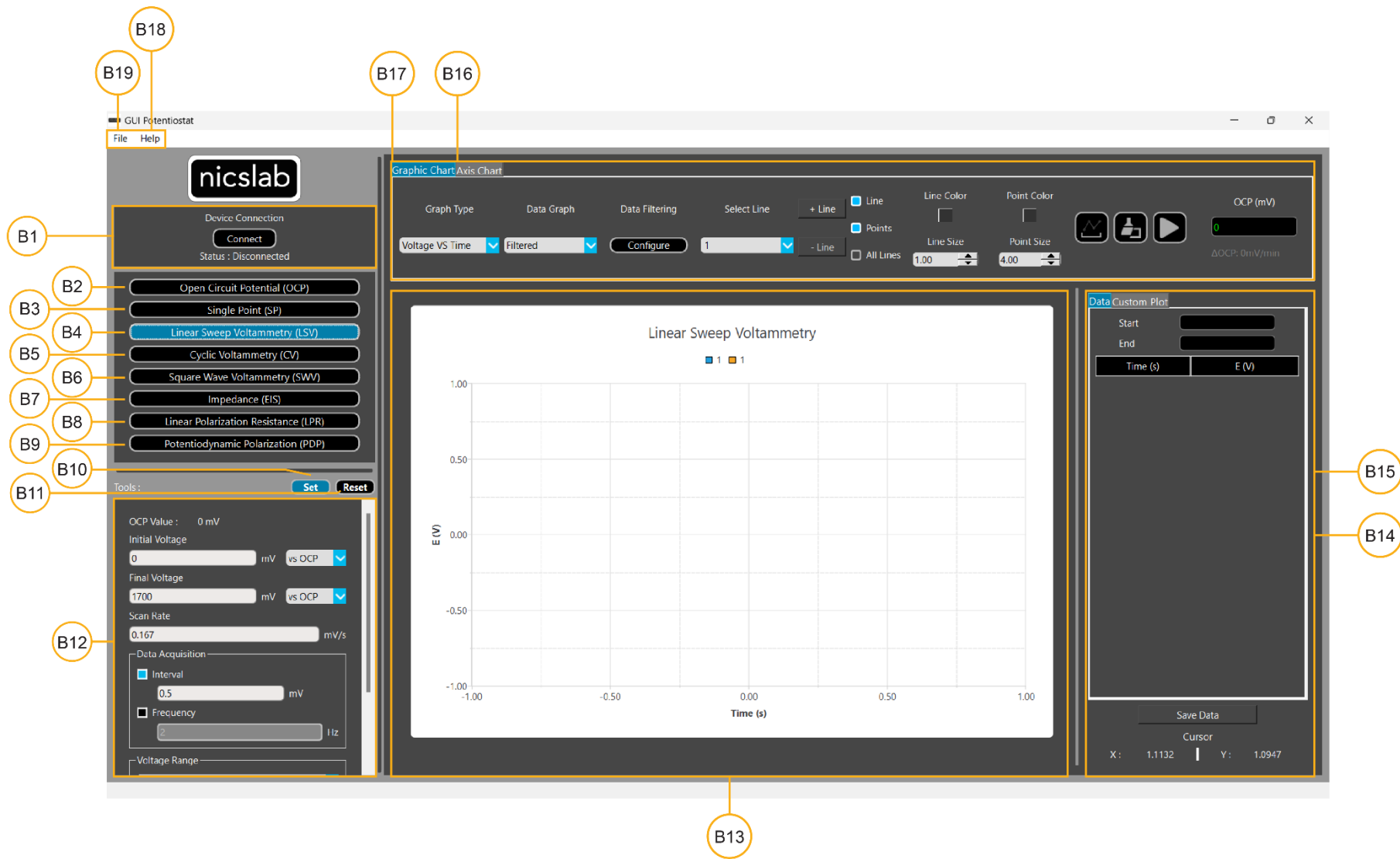

Figure 9. GUI

Note:

| Callout | Description |
|---------|---|
| B1 | Device connection button with connection status |
| B2 | Open Circuit Potential (OCP) button |
| B3 | Single Point (SP) button |
| B4 | Linear Sweep Voltammetry (LSV) button |
| B5 | Cyclic Voltammetry (CV) button |
| B6 | Square Wave Voltammetry (SWV) button |
| B7 | Electrochemical Impedance Spectroscopy (EIS) button |
| B8 | Linear Polarization Resistance (LPR) button |
| B9 | Potentiodynamic Polarization (PDP) button |
| B10 | Set Tools Button |
| B11 | Reset Tools Button |
| B12 | Tools Options (Changes depends on the feature) |
| B13 | Graphic Chart |
| B14 | Data Table Output |
| B15 | Custom Plot Settings |
| B16 | Axis Chart Options |
| B17 | Graphic Chart Options |
| B18 | Help |
| B19 | File Settings |

Initializing the GUI

This section shows how to initialize the GUI:

1. Launch the GUI by double clicking the executable GUI icon.



2. The GUI panel window will open.

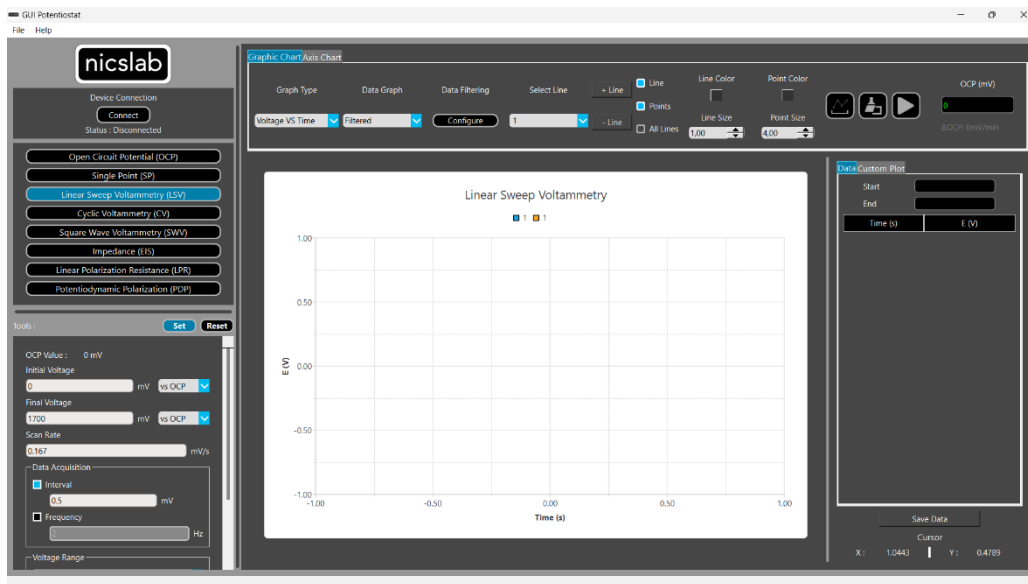

3. To connect the device, click the 'connect' button and wait until the Popup "Device Connected" appears

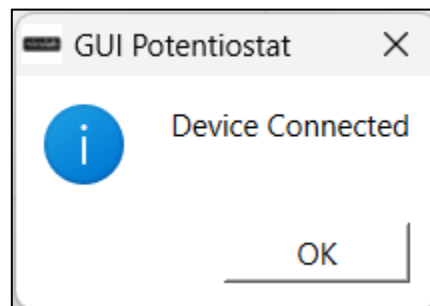
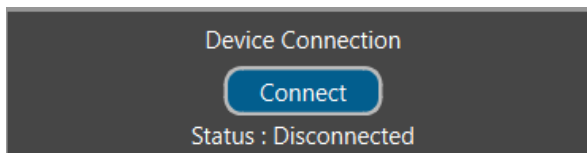

Optional: If you use the earlier version of the GUI, put the correct 'COM' port and click the connect button

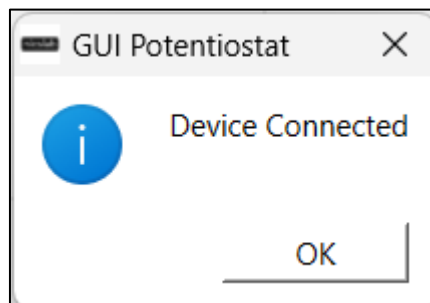
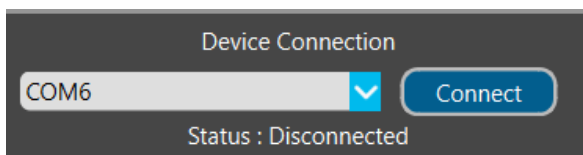

4. Select one of the several features on the left side of the window (B2 – B9)

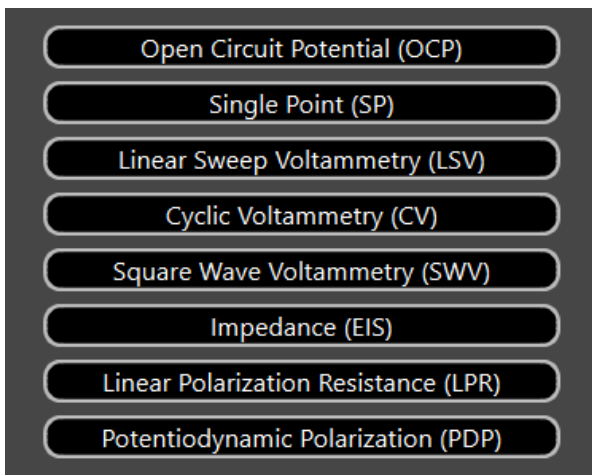

5. Configure the Tools options (B12)

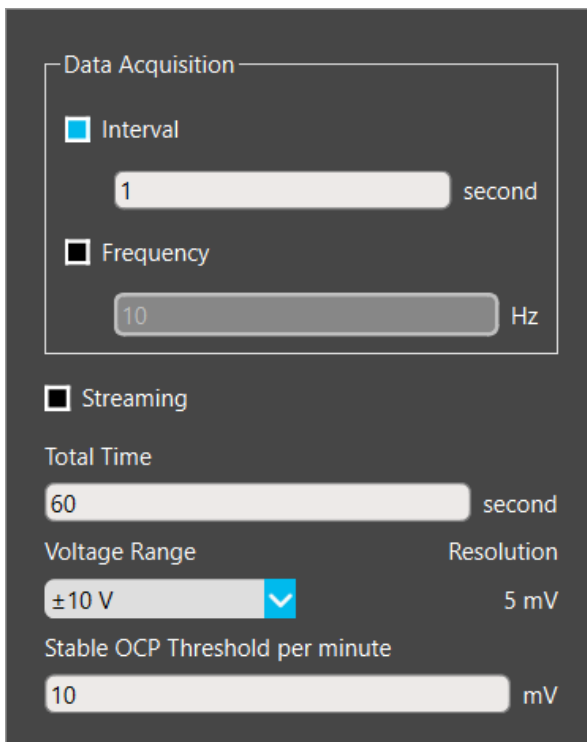

6. Press set (B10) to finalize your settings and send it to the XPOW.



Wait until you got the feedback message box from the device.

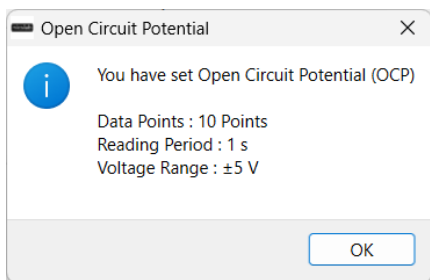

You can also press Reset (B11) to reset your settings to the default value.

- Press the start button in Graphic Chart Options (B17) located around the top right of the window.



- You can see the output value in the data table (B14) and output graph in the graph chart (B13). There will be a progress bar under the graph chart.

| | Time (s) | E (V) |
|----|----------|-----------|
| 1 | 0 | 0.0473022 |
| 2 | 0.01 | 0.0474548 |
| 3 | 0.02 | 0.0469971 |
| 4 | 0.03 | 0.0465393 |
| 5 | 0.04 | 0.0463867 |
| 6 | 0.05 | 0.0464376 |
| 7 | 0.06 | 0.0464303 |
| 8 | 0.07 | 0.0463486 |
| 9 | 0.08 | 0.0463867 |
| 10 | 0.09 | 0.0463257 |



- For finishing the measurement, you can either wait until the progress bar reached 100%, or you can press the start button again (which now changed into stop button). The measurement will finish and a message box will appear

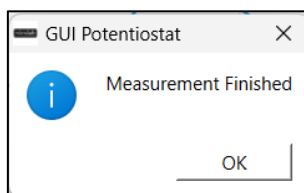

Open Circuit Potential

This feature is used to determine the Open Circuit Potential (OCP) value that needed as a reference when conducting another experiment (LSV, CV, Impedance, etc). The goal of this measurement is to know when the system reached a stable state and record the value. Alternatively, you can set the reference according to RE or a value that you input. There are two ways to conduct OCP, which is passive and active.

Passive OCP Measurement

Passive OCP works by constantly measure the potential difference between the working electrode and reference electrode. To measure passive OCP, you can click on any feature button (B2 – B9). Passive OCP will be started automatically. You can see the passive OCP graph by clicking the OCP line edit. After you click it, the passive OCP graph window will appear.

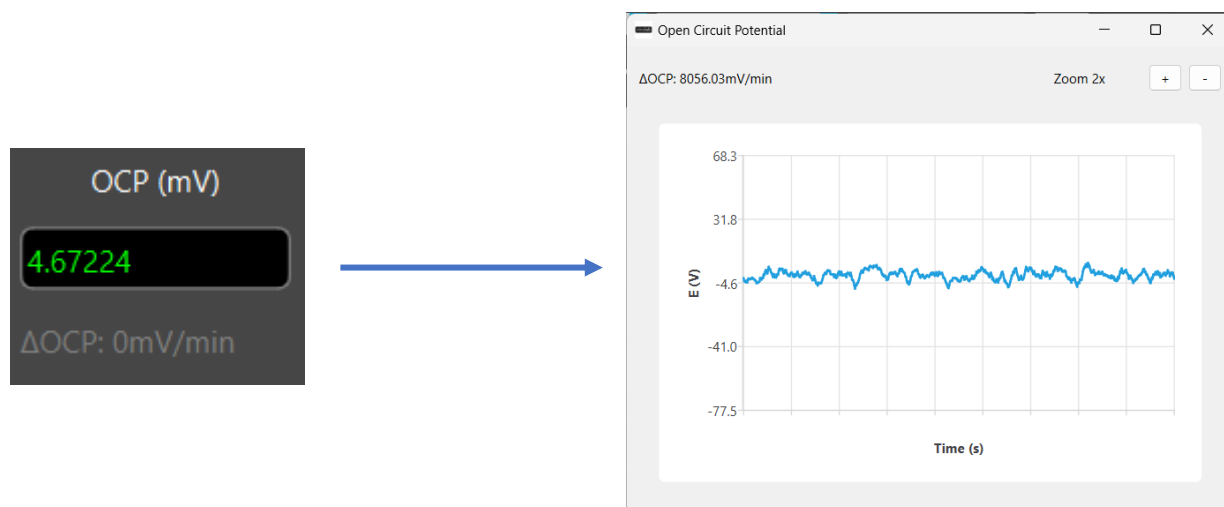

The total OCP information that displayed is within the last 10 minutes. If it not reached 10 minutes yet, the measurement will display information from minute 1 to 10. The information about Δ OCP per minute is displayed on the top left of the window. There are also plus (+) and minus (-) button to zoom in or out on the graph.

To stop the passive OCP measurements, press the "Set Tools" button (B10) on any measurement. Saving or Uploading data will also stops the passive OCP measurement. To begin with passive OCP measurement again, you can click on the features button (B2) again or click on the OCP line edit. The data on the passive OCP graph will not be saved and can be only used as a reference of other measurements. User need to determine whether the Δ OCP is stable enough to do other measurements. To save the OCP value, you need to do an active OCP measurement.

Active OCP Measurement

Active OCP works by setting measurement parameters then manually start the measurement. The measurement value can be seen in graph and will be saved in the program. You can download the data after measurement is finished. On the image below is the Tools Options that you need to fill before you start the measurement.

A. Set Parameters

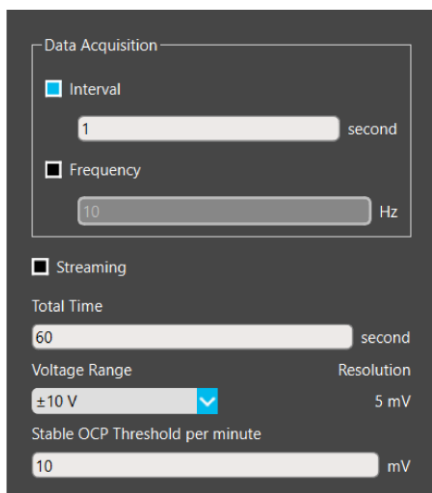

- Choose the **data acquisition method** and show it on the graph. **Streaming** let you continuously get data based on how fast you get from the hardware, **interval** will generate point in chart for each unit of measurement, and **frequency** will generate point based on the frequency you set. The Frequency range is between 0.001 to 2000.
- Set the **voltage range** of your measurement, see Table 4 to check the values.
- Set the **total time** of the OCP measurement. You can set any number. This options will be disabled if you choose streaming method.
- Configure the **stable OCP threshold per minute** to set the minimum OCP value that can be considered stable. The GUI will give a warning when the delta potential value is stable for one minute (stable means the voltage difference is under N mv in the last 1 minute). The default value is 10 mV.

Important note: After you configure the options, always press set (B10) Button. You can also reset the parameters with the reset button (B11).

B. Measurement

Measurement done by clicking start button on the graphic chart options on the upper right side of the window (B17). When the measurement reached the stable value based on the parameter set on the value, the last OCP value will be set on the OCP Line Edit on the upper right of the window. The Global OCP value will also be set with the same value, that will be used on other features. If you stop the measurement early, the OCP value will be set with the last measured value. However, before other measurement is done, you can change or set the OCP value manually by editing the value in the OCP line edit.

Measurement data can be filtered to achieve smoother plot and improve readability. For Open Circuit Potential, the default filtering method is moving average, and it can only be done on the voltage value. See [Data Filtering](#) for more information about data filtering methods.

To end the measurement, you can either press stop button or wait until the measurement is finished based on the total time that you set (except if you toggle on the streaming mode).

Single Point

This feature is used to measure the potential of a single point (static potential).

A. Set Parameters

The screenshot shows a configuration window for a single-point measurement. At the top, it displays 'OCP Value : 0 mV'. Below this, the 'Voltage' section has a text input field set to '200' with 'mV' to its right, and a dropdown menu set to 'vs OCP'. The 'Data Acquisition' section contains two options: 'Interval' (checked) with a text input field set to '1' and 'second' to its right, and 'Frequency' (unchecked) with a text input field set to '5' and 'Hz' to its right. The 'Total Time' section has a text input field set to '200' and 'second' to its right. The 'Voltage Range' section has a dropdown menu set to '±500 mV'. The 'Current Range' section has a checkbox for 'Auto Range' (unchecked) and a dropdown menu set to 'Max' with '±1 A' to its right.

- Set the **voltage input value** (static) in millivolt. You can set the reference according to OCP or RE (Reference Electrode). The default value of RE and OCP is 0. If you have done the OCP measurement, the value will be set on that value.
- Choose the **data acquisition method** and show it on the graph. **Interval** will generate point in chart for each unit of measurement and **frequency** will generate point based on the frequency you set. The Frequency range is between 0.001 to 2000.
- Set the **total time** to set how long the measurement will be conducted.
- Set the **voltage range** of your measurement, see Table 4 to check the value options.
- Set the **current range** of your measurement. Toggle **auto range** ON to let the device to determine the range for you by setting the maximum and minimum range value, or you can choose a fixed range by toggling auto range off. see Table 4 to check the value options.

Important note: After you configure the options, always press set (B10) Button. You can also reset the parameters with the reset button (B11).

B. Measurement

Measurement done by clicking start button on the graphic chart options on the upper right side of the window (B17). Graph is generated continuously based on the value that we get from the device. Then it is plotted based on the graph type that we set. See [Graph types](#) to know more about graph generation.

Measurement data can be filtered to achieve smoother plot and improve readability. For Single Point, the default filtering is done using moving average filter for the voltage and median filter for the current. See [Data Filtering](#) for more information about data filtering methods.

To end the measurement, you can either press stop button or wait until the measurement is finished based on the total time total time (based on frequency or interval), the measurement will stop. You can also stop by pressing the stop button (same button with the start but different symbol now).

Linear Sweep Voltammetry

This feature is used to measure the Linear Sweep Voltammetry (LSV).

A. Set Parameters

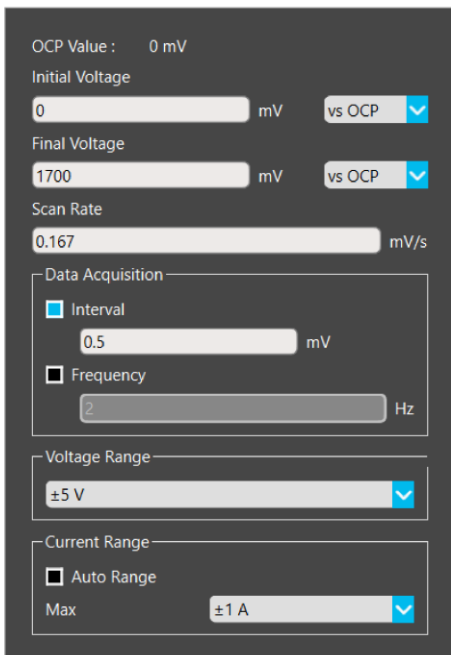

- Set the **initial voltage** input in millivolt. You can set the reference according to OCP or RE (Reference Electrode). The default value of RE and OCP is 0. If you have done the OCP measurement, the value will be set on that value.
- Set the **final voltage** input in millivolt. You can set the reference according to OCP or RE (Reference Electrode). The default value of RE and OCP is 0. If you have done the OCP measurement, the value will be set on that value.
- Set the **scan rate**. This indicates how many mV per second when getting data points.
- Choose the **data acquisition method** and show it on the graph. **Interval** will generate point in chart for each unit of measurement, and **Frequency** will generate point based on the frequency you set. The Frequency range is between 0.001 to 2000.
- Set the **voltage range** of your measurement, see Table 4 to check the value options.
- Set the **current range** of your measurement. Toggle **auto range** ON to let the device to determine the range for you by setting the maximum and minimum range value, or you can choose a fixed range by toggling auto range off. see Table 4 to check the value options.

Important note: After you configure the options, always press set (B10) Button. You can also reset the parameters with the reset button (B11).

B. Measurement

Measurement done by clicking start button on the graphic chart options on the upper right side of the window (B17). Graph is generated continuously based on the value that we get from the device. Then it is plotted based on the graph type that we set. See [Graph types](#) to know more about graph generation.

Measurement data can be filtered to achieve smoother plot and improve readability. For Linear Sweep Voltammetry, the default filtering is done using moving average filter. See [Data Filtering](#) for more information about data filtering methods.

To end the measurement, you can either press stop button or wait until the measurement is finished based on the total time total time (based on frequency or interval), the measurement will stop. You can also stop by pressing the stop button (same button with the start but different symbol now).

Cyclic Voltammetry

This feature is used to measure the Cyclic Voltammetry (CV).

A. Set Parameters

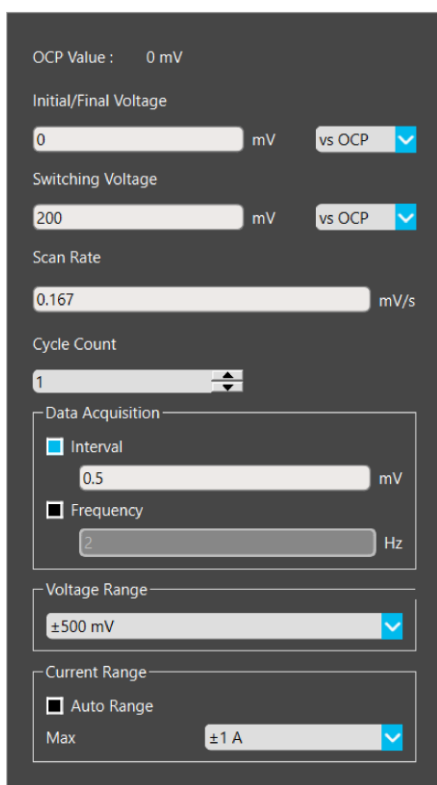

- Set the **initial and final voltage** input in millivolt. You can set the reference according to OCP or RE (Reference Electrode). The default value of RE and OCP is 0. If you have done the OCP measurement, the value will be set on that value.
- Set the **switching voltage** input in millivolt. You can set the reference according to OCP or RE (Reference Electrode). The default value of RE and OCP is 0. If you have done the OCP measurement, the value will be set on that value.
- Set the **scan rate**. This indicates how many mV per second when getting data points.
- Set the **cycle count**. This indicates how many up-and-down cycles you need the device to produce to the electrodes.
- Choose the **data acquisition method** and show it on the graph. **Interval** will generate point in chart for each unit of measurement, and **Frequency** will generate point based on the frequency you set. The Frequency range is between 0.001 to 2000.
- Set the **voltage range** of your measurement, see Table 4 to check the value options.
- Set the **current range** of your measurement, Toggle **auto range ON** to let the device to determine the range for you by setting the maximum and minimum range value, or you can choose a fixed range by toggling auto range off. see Table 4 to check the value options.

Important note: After you configure the options, always press set (B10) Button. You can also reset the parameters with the reset button (B11).

B. Measurement

Measurement done by clicking start button on the graphic chart options on the upper right side of the window (B17). Graph is generated continuously based on the value that we get from the device. Then it is plotted based on the graph type that we set. See [Graph types](#) to know more about graph generation.

Measurement data can be filtered to achieve smoother plot and improve readability. For Cyclic Voltammetry, the default filtering is done using moving average filter. See [Data Filtering](#) for more information about data filtering methods.

To end the measurement, you can either press stop button or wait until the measurement is finished based on the total time total time (based on frequency or interval), the measurement will stop. You can also stop by pressing the stop button (same button with the start but different symbol now).

Electrochemical Impedance Spectroscopy

This feature is used to measure the Electrochemical Impedance Spectroscopy (EIS). To do this mode, you need to press the EIS Button. After that fill all the parameters displayed in the tools section (B12).

A. Set Parameters

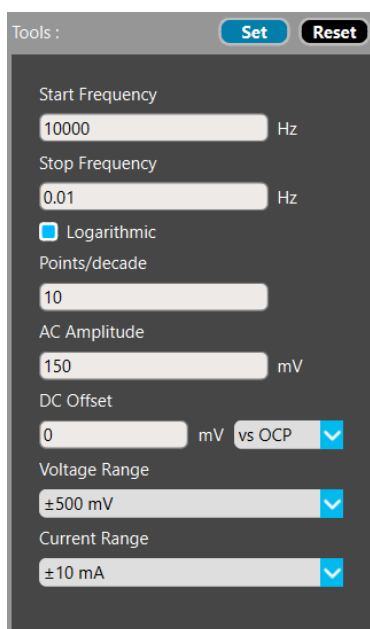

The screenshot shows the 'Tools' section of the software interface. It contains several input fields and checkboxes for configuring the EIS measurement. The parameters are: Start Frequency (10000 Hz), Stop Frequency (0.01 Hz), Logarithmic (checked), Points/decade (10), AC Amplitude (150 mV), DC Offset (0 mV vs OCP), Voltage Range (±500 mV), and Current Range (±10 mA). There are 'Set' and 'Reset' buttons at the top right of the panel.

- Set the **start frequency** input in Hz. You can set the value from 0.01 to 100000. Must be higher than Stop Frequency
- Set the **stop frequency** input in Hz. You can set the value from 0.01 to 100000. Must be lower than Start Frequency
- Set whether you want to increment the frequency in **logarithmic** or not by checking the Logarithmic checkbox
- Set the **Points/Decade** or **Points/Sweep**. This indicates how many points per decade frequency (in logarithmic mode) or points per sweep (in linear mode) when getting data points. If you choose Logarithmic, the total points will be this input multiplied by how many decades from start to stop frequency. If you choose Linear, the total points will be the same as this input.
- Choose the **AC amplitude** and to set the amplitude of the voltage waves that you will apply to the electrode
- Set the **DC offset** in mV. You can set the reference according to OCP or RE (Reference Electrode). The default value of RE and OCP is 0. If you have done the OCP measurement, the value will be set on that value.

- g. Set the **voltage range** of your measurement, see Table 4 to check the value options.
- h. Set the **current range** of your measurement. see Table 4 to check the value options.

Important note: After you configure the options, always press set (B10) Button. You can also reset the parameters with the reset button (B11).

B. Measurement

Measurement done by clicking start button on the graphic chart options on the upper right side of the window (B17). Graph is generated continuously based on processed data from the timestamp, voltage, and current data (array). Then it is plotted based on the graph type that we set. See [Graph types](#) to know more about graph generation.

Measurement data can be filtered to achieve smoother plot and improve readability. For Electrochemical Impedance Spectroscopy, the filtering is done using Low Pass Filter. The filter is applied on all data, so when there is a new data, all data is filtered again. The filter works by filtering the data that have a higher frequency than the one we set. What remains is the data that have the same frequency or lower than we set. The parameter is The Frequency value that have been set on current measurement. The sampling rate is 100x frequency. See [Data Filtering](#) for more information about data filtering methods.

To end the measurement, you can either press stop button or wait until the measurement is finished based on the total time total time (based on frequency or interval), the measurement will stop. You can also stop by pressing the stop button (same button with the start but different symbol now).

Linear Polarization Resistance

This feature is used to measure the Linear Polarization Resistance (LPR). It is almost the same as LSV.

A. Set Parameters

The screenshot shows a control panel for Linear Polarization Resistance. At the top, 'OCP Value' is set to 0 mV. Below, 'Initial Voltage' is set to -300 mV vs OCP. 'Final Voltage' is set to 300 mV vs OCP. 'Scan Rate' is 0.167 mV/s. Under 'Data Acquisition', 'Interval' is selected with a value of 0.5 mV, and 'Frequency' is unselected with a value of 2 Hz. 'Voltage Range' is set to ±1 V. 'Current Range' is set to Max with a value of ±1 A. A 'Linear Polarization Resistance' button is at the bottom.

- Set the **initial voltage** input in mV. You can set the reference according to OCP or RE (Reference Electrode). The default value of RE and OCP is 0. If you have done the OCP measurement, the value will be set on that value.
- Set the **final voltage** input in mV. You can set the reference according to OCP or RE (Reference Electrode). The default value of RE and OCP is 0. If you have done the OCP measurement, the value will be set on that value.
- Set the **scan rate**. This indicates how many mV per second when getting data points.
- Choose the **data acquisition method** and show it on the graph. **interval** will generate point in chart for each unit of measurement, and **frequency** will generate point based on the frequency you set. The Frequency range is between 0.001 to 2000.
- Set the **voltage range** of your measurement, see Table 4 to check the value options.
- Set the **current range** of your measurement. see Table 4 to check the value options.
- Click the **Linear Polarization Resistance** button to open Linear Polarization Resistance window.

Important note: After you configure the options, always press set (B10) Button. You can also reset the parameters with the reset button (B11).

B. Measurement

Measurement done by clicking start button on the graphic chart options on the upper right side of the window (B17). Graph is generated continuously based on the value that we get from the device. Then it is plotted based on the graph type that we set. See [Graph types](#) to know more about graph generation.

Measurement data can be filtered to achieve smoother plot and improve readability. For Linear Polarization Resistance, the default filtering is done using moving average filter. See [Data Filtering](#) for more information about data filtering methods.

To end the measurement, you can either press stop button or wait until the measurement is finished based on the total time total time (based on frequency or interval), the measurement will stop. You can also stop by pressing the stop button (same button with the start but different symbol now).

Potentiodynamic Polarization (PDP)

This feature is used to measure the Potentiodynamic Polarization (PDP). It is almost the same as LSV.

A. Set Parameters

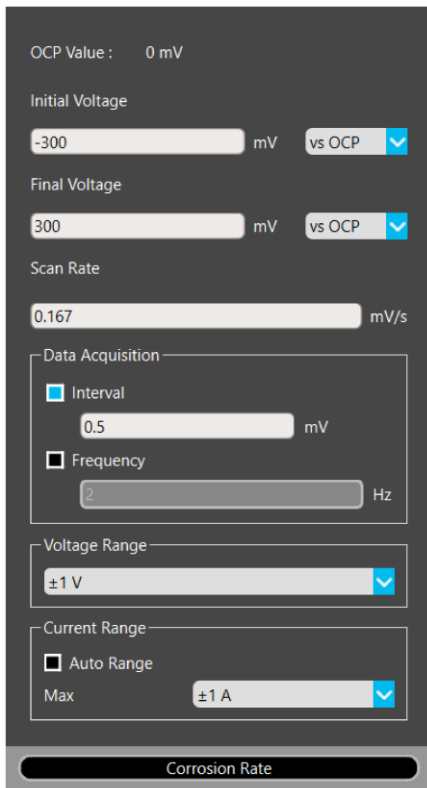

- Set the **initial voltage** input in mV. You can set the reference according to OCP or RE (Reference Electrode). The default value of RE and OCP is 0. If you have done the OCP measurement, the value will be set on that value.
- Set the **final voltage** input in mV. You can set the reference according to OCP or RE (Reference Electrode). The default value of RE and OCP is 0. If you have done the OCP measurement, the value will be set on that value.
- Set the **scan rate**. This indicates how many mV per second when getting data points.
- Choose the **data acquisition method** and show it on the graph. **interval** will generate point in chart for each unit of measurement, and **frequency** will generate point based on the frequency you set. The Frequency range is between 0.001 to 2000.
- Set the **voltage range** of your measurement, see Table 4 to check the value options.
- Set the **current range** of your measurement. see Table 4 to check the value options.
- Corrosion Rate** button to open corrosion rate window.

Important note: After you configure the options, always press set (B10) Button. You can also reset the parameters with the reset button (B11).

B. Measurement

Measurement done by clicking start button on the graphic chart options on the upper right side of the window (B17). Graph is generated continuously based on the value that we get from the device. Then it is plotted based on the graph type that we set. See [Graph types](#) to know more about graph generation.

Measurement data can be filtered to achieve smoother plot and improve readability. For Potentiodynamic Polarization, the default filtering is done using moving average filter. See [Data Filtering](#) for more information about data filtering methods.

To end the measurement, you can either press stop button or wait until the measurement is finished based on the total time total time (based on frequency or interval), the measurement will stop. You can also stop by pressing the stop button (same button with the start but different symbol now).

Voltage & Current Range

When you set voltage and current range for your measurements, there are fixed values that will determine the maximum value your device can measure and display on the graph. Lower current range equals higher accuracy, but the reading range is also capped at the value. Make sure to configure the voltage and current value before measurement starts. The values are as follows:

Table 4. Voltage & Current Range

| Type | Value |
|---------|------------------------------|
| Voltage | $\pm 10\text{ V}$ |
| | $\pm 5\text{ V}$ |
| | $\pm 1\text{ V}$ |
| | $\pm 500\text{ mV}$ |
| Current | $\pm 1\text{ A}$ |
| | $\pm 100\text{ mA}$ |
| | $\pm 10\text{ mA}$ |
| | $\pm 1\text{ mA}$ |
| | $\pm 100\text{ }\mu\text{A}$ |
| | $\pm 10\text{ }\mu\text{A}$ |

For current range, you have the options to enable auto range. This feature enable user to configure the upper and lower bound of the range. The device will adjust the range based on the maximum current value that read by the device. It is advised to use this feature when current value reading range is not known.

Corrosion Rate via Linear Polarization Resistance

After doing a Linear Polarization Resistance sweep test, you can determine corrosion rate value using Polarization Resistance value. To get corrosion rate, this is the steps:

1. The first thing you need to do is open Current vs Voltage graph.

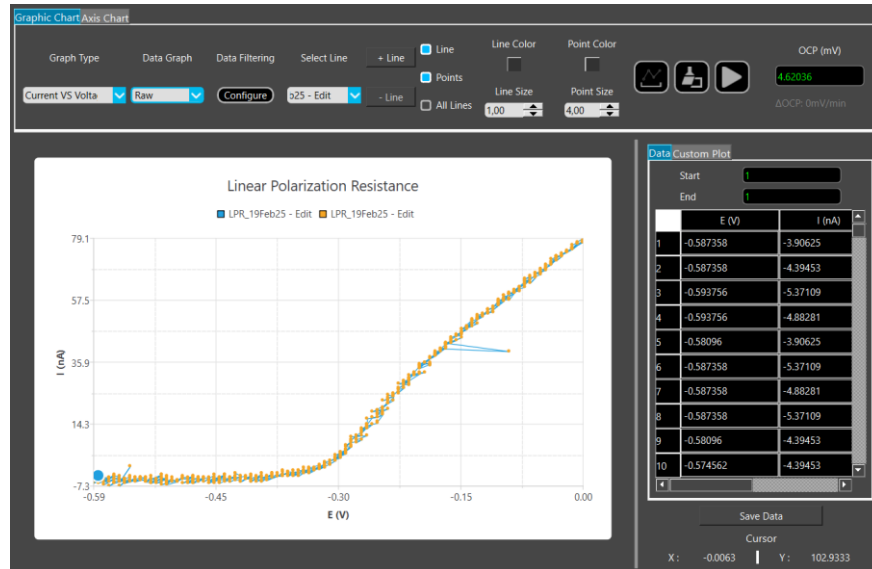

You can do measurement first or you can use previously gathered data saved from previous measurements by using the File -> Upload button (B19)

2. Then adjust the Filter Window to smooth the signal. Don't forget to hide the points so you can see the line better

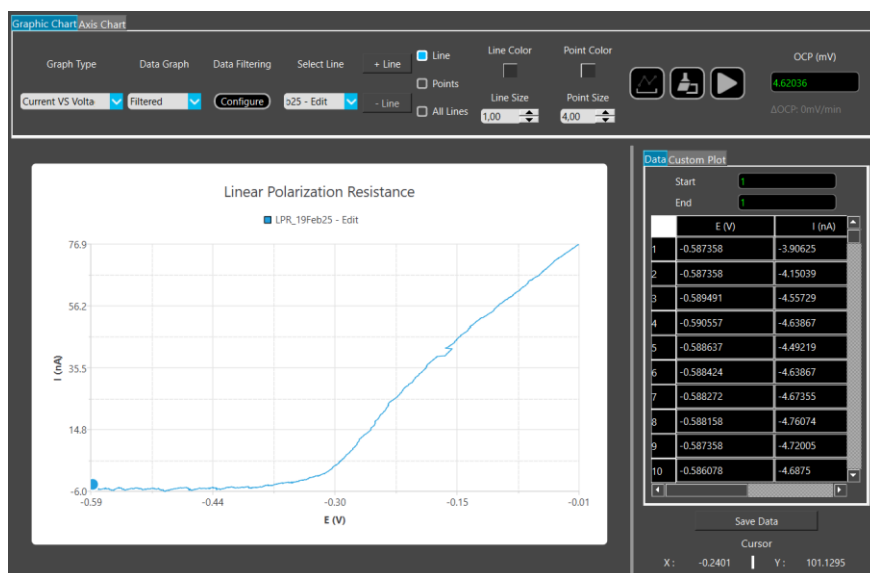

- On the Custom Plot tab, move the point 1 and point 2 sliders, you can adjust the position of the point 1 and point 2 on the graph. Put both points on the slope, then click Add points button. Both of the points will be visible as x and y value on the table.

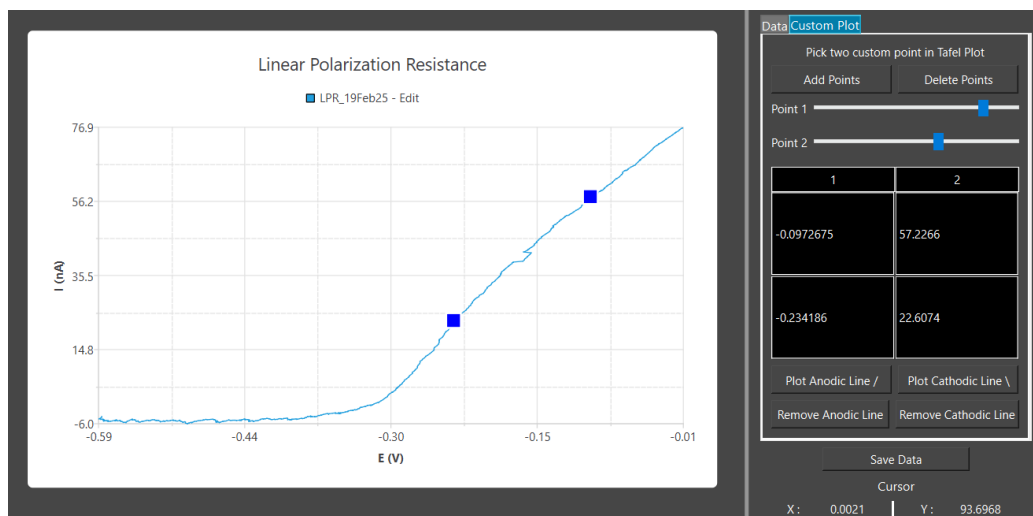

- Click Plot Anodic Line button for doing a linear regression on "/" line and Cathodic Line button for doing a linear regression on "\" line. Linear regression line of the data points between point 1 and 2 will be plotted to the edge of the graph.

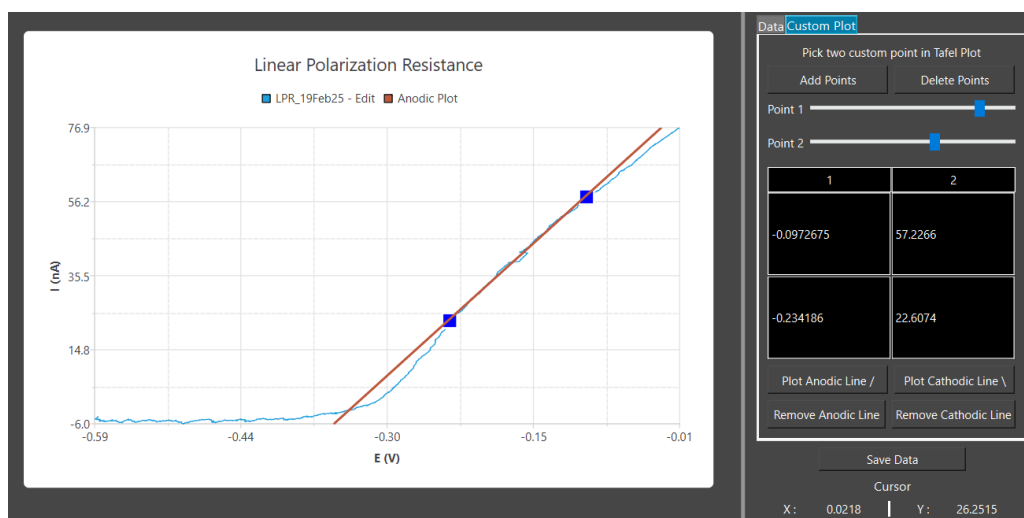

Important note: a message box will appear which shows the plotting process is currently undergoes, please do not click anything until the plotting process is completed. If plotting process is more than 30 second and a warning appears, it means the data is not enough or too much plotted data. Please follow the instruction in the message box.

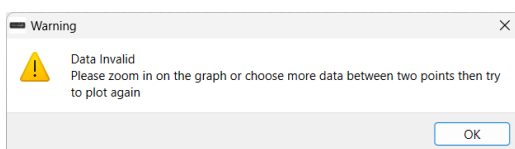

5. Click Linear Polarization Resistance button on the bottom part of tool options (B12).

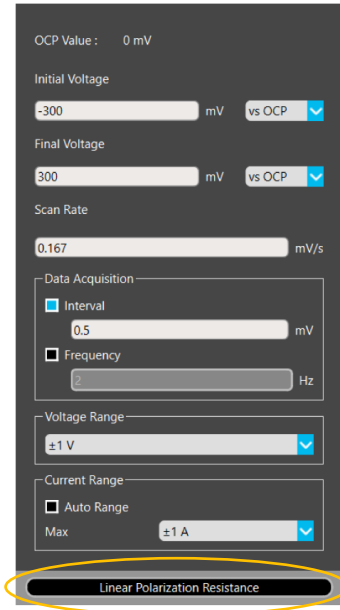

6. When Linear Polarization Resistance button is clicked, there will be a window opened:

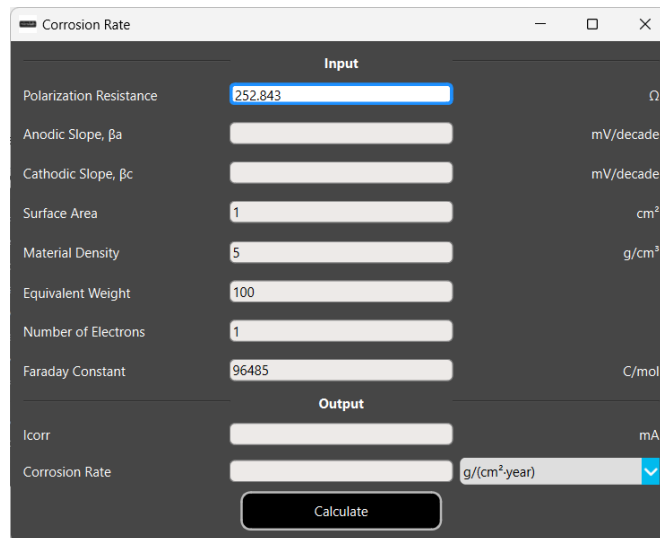

Notice that the Polarization Resistance Input is already filled by the slope value of the linear polarization resistance you plotted before

7. Input the Anodic & Cathodic Slope, Surface Area, Material Density, Equivalent Weight, and Number of Electrons (The Faraday Constant is already Filled)

8. Click Calculate button to calculate i_{corr} , E_{corr} , and Corrosion Rate. The Calculation is using Stern-Geary Equation:

Stern-Geary Constant

$$B = \frac{\beta_a * \beta_c}{2.303 * (\beta_a + \beta_c)}$$

- β_a = **anodic Tafel slope** (V/decade or mV/decade)
- β_c = **cathodic Tafel slope** (V/decade or mV/decade)

i_{corr} (A / cm²)

$$i_{corr} = \frac{B}{(R_p * A)}$$

- R_p = **Polarization Resistance** (Ω).
- A = **Surface area** (cm²)

R_p gained from measurement is multiplied by surface area to normalize it

Equivalent Weight

$$EW = \frac{M}{n}$$

- M = **Atomic or Molecular Weight** (g/mol).
- n = **Electron per Reaction / valence**

Corrosion Rate (mm/y)

$$CR = \frac{K * i_{corr} * EW}{\rho}$$

- K = **Conversion Factor** derived from Faraday's Law of electrolysis, the value is 3272 if the i_{corr} is in A
- EW = **Equivalent Weight** = (g/equivalent or g/mol when used with valence n)
- ρ = **Density** (g/cm³)

You can change the unit of measurement for the corrosion rate:

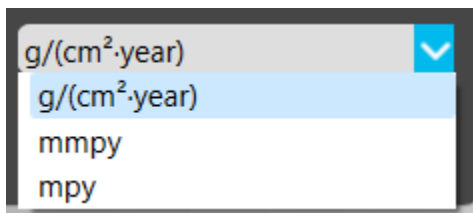

If there is a value inside the corrosion rate line edit, it will change according to the unit of measurement instantly.

Corrosion Rate via Potentiodynamic Polarization (Tafel Extrapolation)

After doing a potentiodynamic polarization sweep test, you can determine corrosion rate value using Tafel extrapolation method. To get corrosion rate, this is the steps:

1. The first thing you need to do is open Tafel Plot graph, it usually shaped like this:

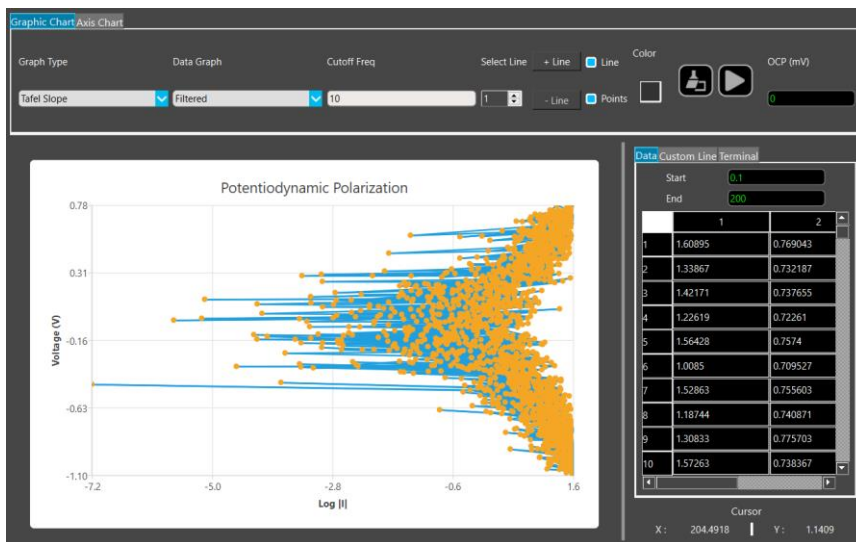

You can do measurement first or you can use previously gathered data saved from previous measurements by using the File -> Upload button (B19)

2. Then adjust the Filter Window to smooth the signal. Don't forget to hide the points so you can see the line better

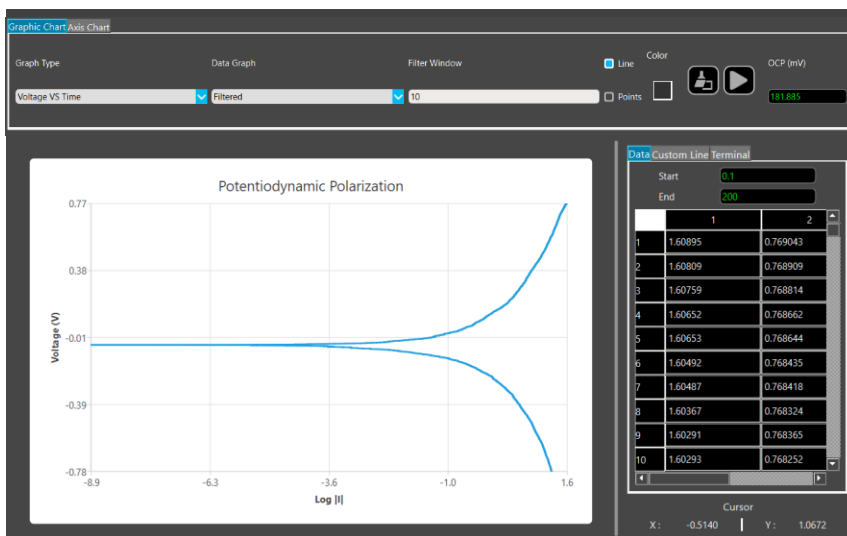

- On the Custom Plot tab, move the point 1 and point 2 sliders, you can adjust the position of the point 1 and point 2 on the graph. Put both points on the upper slope for anode plotting, and bottom slope for cathodic plotting. then Add points button. Both of the points will be visible as x and y value on the table.

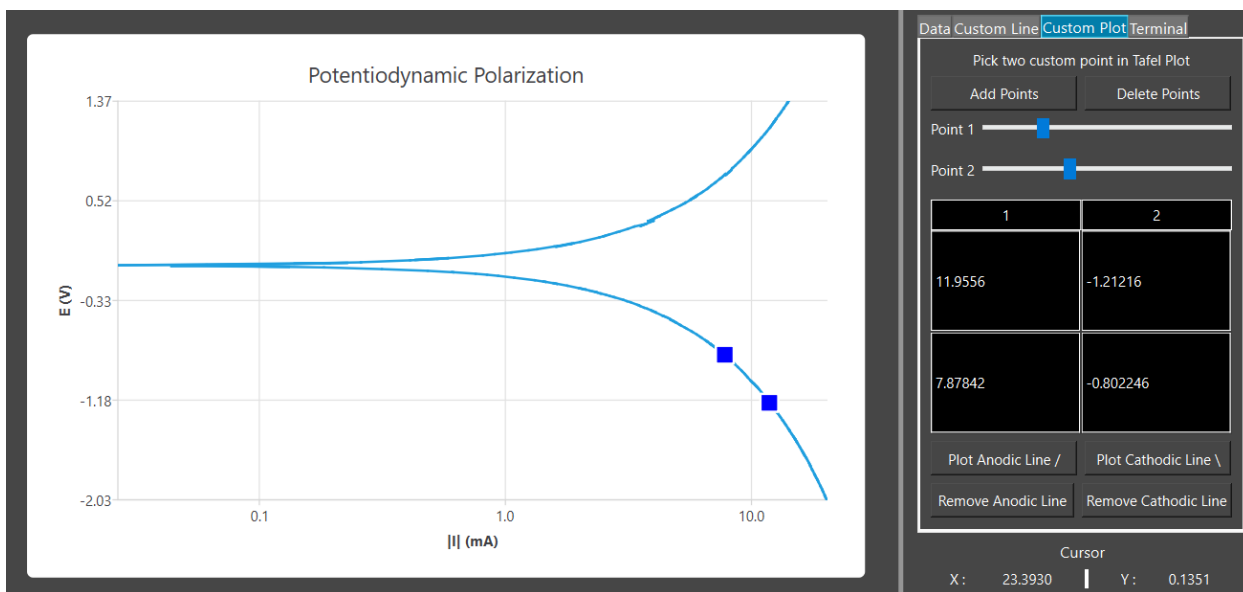

- Click Plot Anodic Line button, a linear regression line of the data points between point 1 and 2 will be plotted to the edge of the graph.

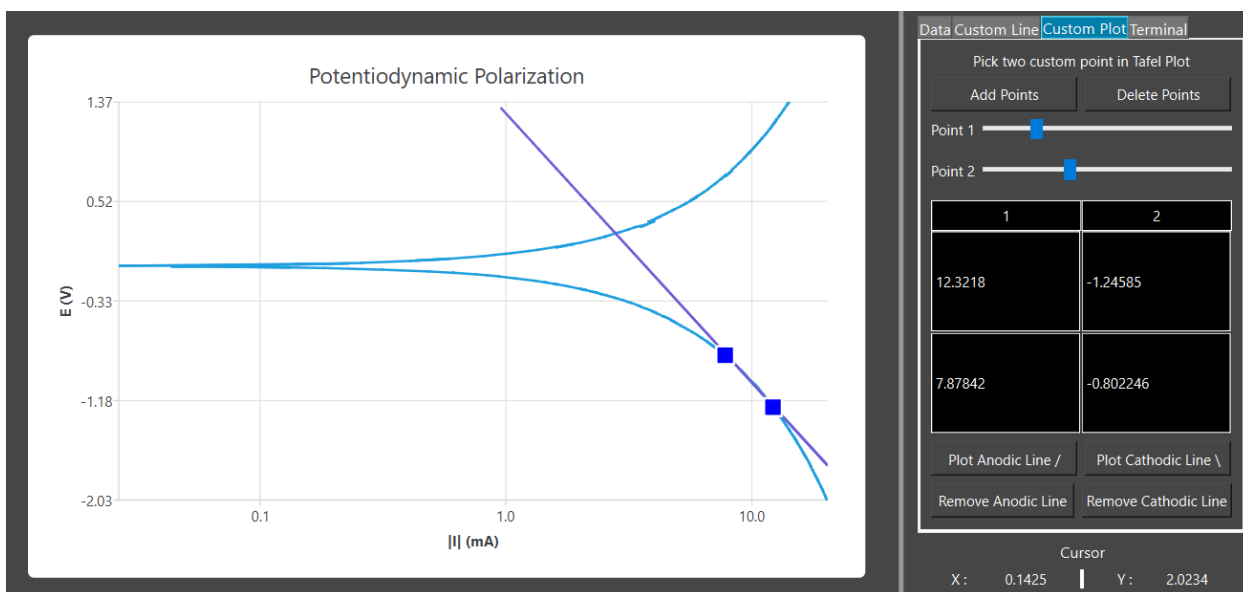

Important note: a message box will appear which shows the plotting process is currently undergoes, please do not click anything until the plotting process is completed. If plotting process is more than 30 second

and a warning appears, it means the data is not enough or too much plotted data. Please follow the instruction in the message box.

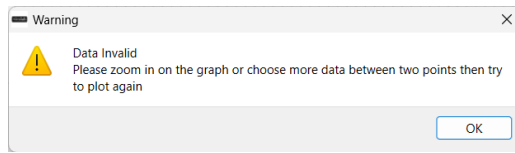

- Repeat step 3 and 4 for the upper/bottom slope to plot both anodic and cathodic lines.

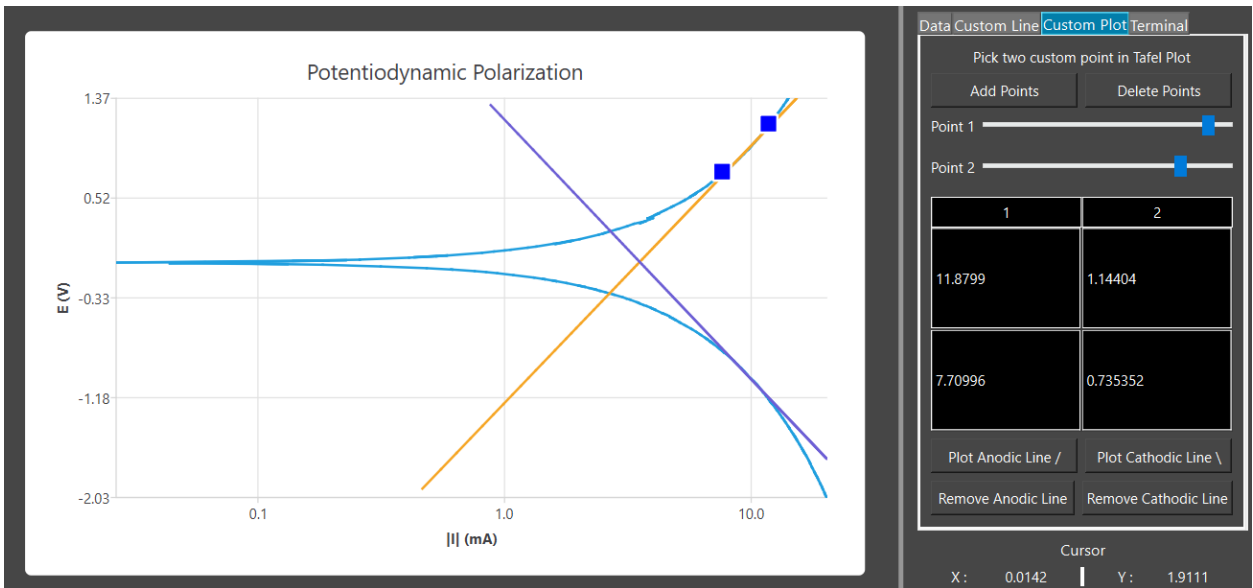

- Press corrosion rate button on the bottom of the PDP settings.

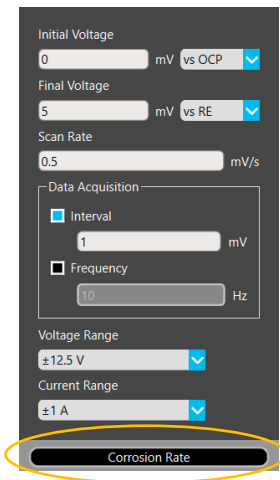

When Corrosion Rate button is clicked, there will be a window opened:

7. Notice that the Anodic and Cathodic Slope Input is already filled by the slope value of the anodic and cathodic lines you plotted before
8. Input the Surface Area, Material Density, Equivalent Weight, and Number of Electrons (The Faraday Constant is already Filled)
9. Click Calculate button to calculate I_{corr} , E_{corr} , and Corrosion Rate. The Calculation is using Faraday's Law of Electrolysis:

E_{corr}

The intersection point of the two slopes, specifically the y axis value

I_{corr}

The intersection point of the two slopes, specifically the x axis value. Normalize it by dividing it with surface area (A).

Stern-Geary Constant

$$B = \frac{\beta_a * \beta_c}{2.303 * (\beta_a + \beta_c)}$$

- β_a = anodic Tafel slope (V/decade or mV/decade)
- β_c = cathodic Tafel slope (V/decade or mV/decade)

Polarization Resistance (Ω)

$$R_p = \frac{B}{(i_{\text{corr}} * A)}$$

- A = **Surface area** (cm^2)

R_p gained from measurement is divided by surface area to normalize it, so the unit is from $\Omega \cdot \text{cm}^2$ to Ω

Equivalent Weight

$$EW = \frac{M}{n}$$

- M = **Atomic or Molecular Weight** (g/mol).
- n = **Electron per Reaction / valence**

Corrosion Rate (mm/y)

$$CR = \frac{K * i_{\text{corr}} * EW}{\rho}$$

- K = **Conversion Factor** derived from Faraday's Law of electrolysis, the value is 3272 if the i_{corr} is in A
- EW = **Equivalent Weight** = (g/equivalent or g/mol when used with valence n)
- ρ = **Density** (g/cm^3)

10. You can change the unit of measurement for the corrosion rate:

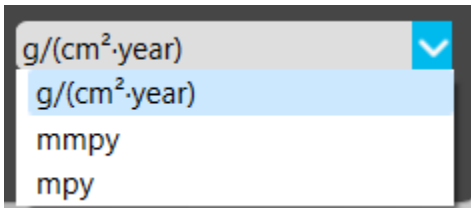

If there is a value inside the corrosion rate line edit, it will change according to the unit of measurement instantly. Make sure that you already do tafel plot before you change the unit.

Output Data

In this area (B14) you can see all the output data from the potentiostat. Each data is plotted on the graphic chart. You can choose individual data then highlight it, then see the point directly in the graphic chart.

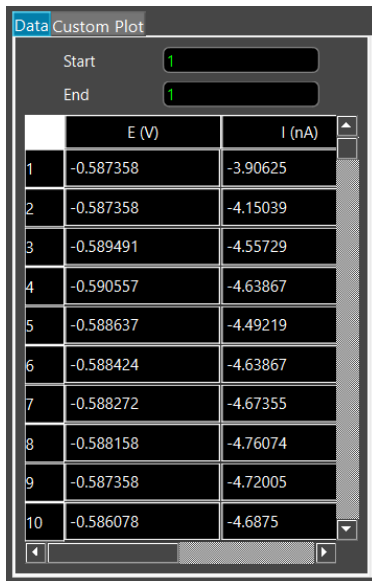

| | E (V) | I (nA) |
|----|-----------|----------|
| 1 | -0.587358 | -3.90625 |
| 2 | -0.587358 | -4.15039 |
| 3 | -0.589491 | -4.55729 |
| 4 | -0.590557 | -4.63867 |
| 5 | -0.588637 | -4.49219 |
| 6 | -0.588424 | -4.63867 |
| 7 | -0.588272 | -4.67355 |
| 8 | -0.588158 | -4.76074 |
| 9 | -0.587358 | -4.72005 |
| 10 | -0.586078 | -4.6875 |

Custom Line Settings

In this area (B15) you can configure custom plot. First you move the Point 1 and Point 2 slider, it will determine the data point position on the graph. Then you press the Add Point button to add marker to the two points. After that you can press plot anodic line or cathodic line to create a linear regression between two points. The line will extend to the graph frame maximum value. To remove a line, click Remove Anodic Line or Remove Cathodic Line button. This feature is specifically tailored for Tafel plot in Potentiodynamic Polarization and Linear Polarization Resistance measurement.

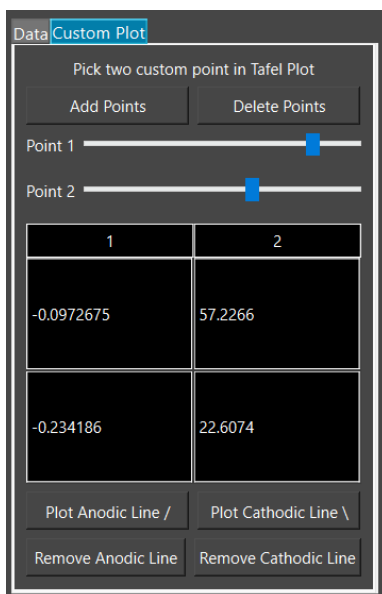

Pick two custom point in Tafel Plot

Add Points Delete Points

Point 1

Point 2

| 1 | 2 |
|------------|---------|
| -0.0972675 | 57.2266 |
| -0.234186 | 22.6074 |

Plot Anodic Line / Plot Cathodic Line \

Remove Anodic Line Remove Cathodic Line

Graphic Chart Options

In this area (B17) you can configure the graphic chart options. You can choose which graph types that you want to plot. The data graph can also be configured to raw or filtered. There is a filter window input to configure the filtering of data shown on the graphic chart. Other options including add custom linear line, change graph line color, clear graphic chart, run (measure) & pause, save, upload, and input OCP.

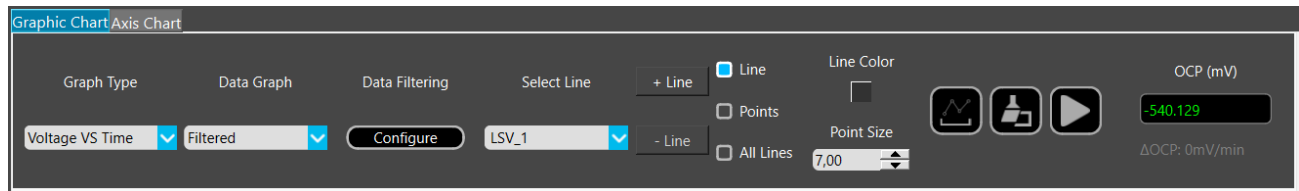

For EIS feature, the graphic chart options is different than the rest of features. you cannot configure the filter window and choose the graph between raw or filtered because the filtering value is programmatically determined (low pass filter) and done on the voltage and current value.

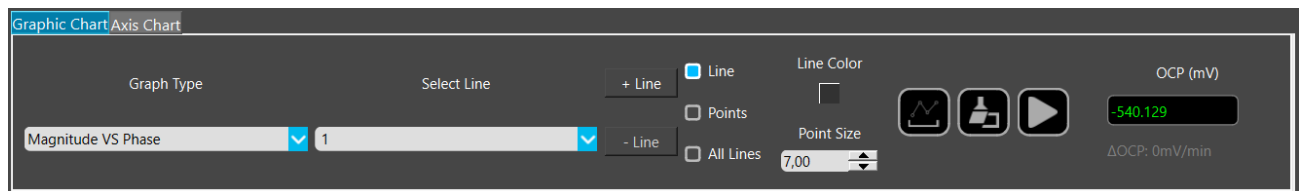

This is the description for each configuration in graphic chart options:

Graph types

You can configure the graph type to show on the graphic chart. Every graph type utilizes either data generated by the device itself or data that has been uploaded. Additionally, various data filtering methods can be applied to this data. The amount of graph types differs for each feature.

- a. Open Circuit Potential (OCP)
 - Voltage (V) VS Time (s).
- b. Single Point (SP)
 - Voltage (V) VS Time (s)
 - Current (mA) VS Time (s)
 - Voltage (V) VS Current (mA)
- c. Linear Sweep Voltammetry (LSV)
 - Voltage (V) VS Time (s)

- Current (mA) VS Time (s)
 - Voltage (V) VS Current (mA)
- a. Cyclic Voltammetry (CV)
- Voltage (V) VS Time (s)
 - Current (mA) VS Time (s)
 - Voltage (V) VS Current (mA)
- b. Electrochemical Impedance Spectroscopy (EIS)
- Magnitude (dB) VS Phase (°)
 - Magnitude (dB) VS Frequency (Hz) - **Bode Plot**
 - Phase (°) VS Frequency (Hz) - **Bode Plot**
 - Z Real (Ω) VS Z Imaginary (Ω) - **Nyquist Plot**
 - Power Spectrum Density (V^2/Hz) VS Frequency (Hz)
 - Power Spectrum Density (A^2/Hz) VS Frequency (Hz)
 - Noise Spectrum Density (V / \sqrt{Hz}) VS Frequency (Hz)
 - Noise Spectrum Density (A / \sqrt{Hz}) VS Frequency (Hz)
- c. Linear Polarization Resistance
- Voltage (V) VS Time (s)
 - Current (mA) VS Time (s)
 - Voltage (V) VS Current (mA)
- d. Potentiodynamic Polarization
- Voltage (V) VS Time (s)
 - Current (mA) VS Time (s)
 - Voltage (V) VS Current (mA)
 - Voltage (V) VS LogI(mA) - Tafel Plot

Data Graph

You can change whether you want to display raw data or filtered data on the graphic chart. This feature usually applied when voltage and current value is plotted on the graphic chart.

Data Filtering

The data plotted on graph (B13) can be filtered, allowing for clearer visualization and better understanding. This can only be done before or after the measurement. User can configure the filtering methods and parameters by clicking on the configure button designated for data filtering. After clicked, a window will be opened.

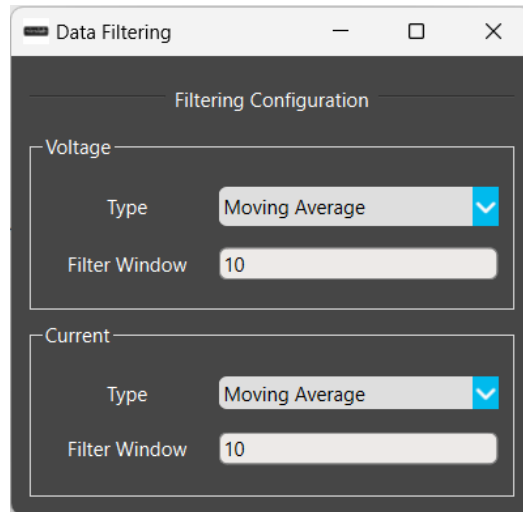

Three filtering methods are available, each with adjustable parameters for your convenience.

a. Moving Average Filter

The filter applied on the last x data points that can be set on filter window. It works by averaging a set amount of data in a window. The window moves based on the last data, so the filter always applied on the last x data points. This filtering method use filter window as a parameter, which ranges from 1 (no filter) to N (the amount of data). The default value is 10 data points.

b. Median Filter

The filter applied on the last x data points that can be set on filter window. It works by calculating the median value for every data in a window. The window moves based on the last data, so the filter always applied on the last x data points. This filtering method use filter window as a parameter, which ranges from 1 (no filter) to N (the amount of data). The default value is 10 data points.

c. Exponential Smoothing (Filter)

Exponential smoothing is a statistical method for time series forecasting. It assigns exponentially decreasing weights to historical data, emphasizing recent observations while reducing the impact of older data. By adjusting the smoothing factor (often denoted as α), you control the balance between responsiveness and stability in your forecasts.

d. Low Pass Filter

For Electrochemical Impedance Spectroscopy, the filtering is done using Low Pass Filter. The filter is applied on all data, so when there is a new data, all data is filtered again. The filter works by filtering the data that have a higher frequency than the one we set. What remains is the data that have the same frequency or lower than we set.

Line Options

You can add new lines to start a new measurement without deleting the previous one. You can also freely select between lines of a maximum 5 lines. Line title can be changed freely by typing in the line edit. Uploaded file name also will be directly displayed as line title. Line and point can be show/hide. All lines of multiple measurements can be shown or only show the current selected line. Measurement can be done with previous line plotted for easier comparison. Line color and show/hide line and points can also be done for each line. Finally, you can also adjust the data point size.

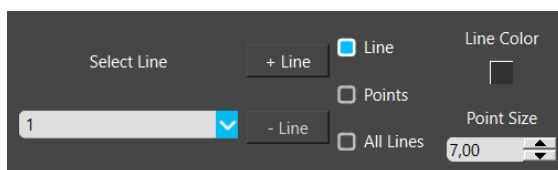

Save Graph

You can save the graph chart (B13) as image by clicking the save graph button. It is located beside the line options. After clicking the button, you may choose the saved file directory and name, then save. The default save format is .png.



Chart

Press the Clear Graphic Chart button to clear the graph chart output (B13), it is located beside the run button on the top right of the window.

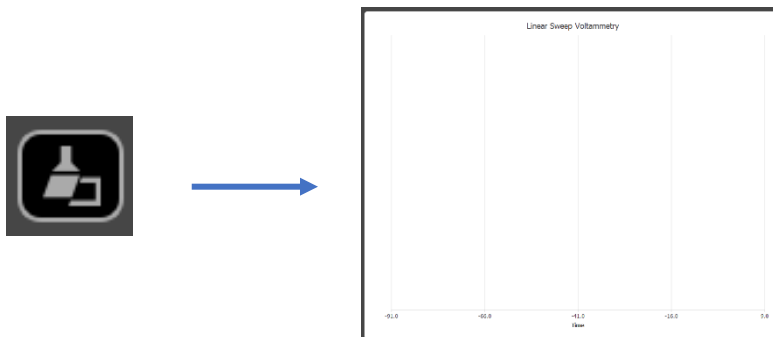

Start / Stop

Press the start button to begin the graph chart output (B13) generation and press it again to stop.

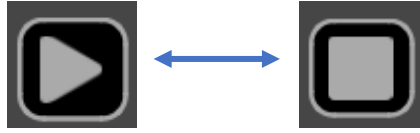

OCP value (mV)

This section displays the OCP value after you have done the Open Circuit Potential (OCP) measurement. The OCP value will be used as a reference each time you do a measurement other than OCP and selecting "vs OCP" on the set parameters. This value will change when you do a passive or active OCP measurements.

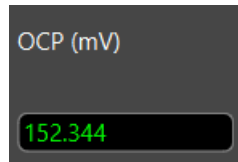

You can click the value in the box, and then a new window will appear, similar to this:

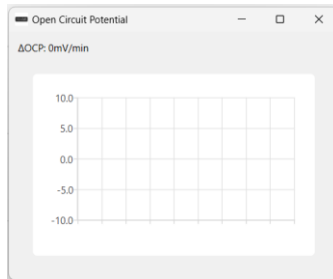

In this window, you can monitor the OCP value in real-time.

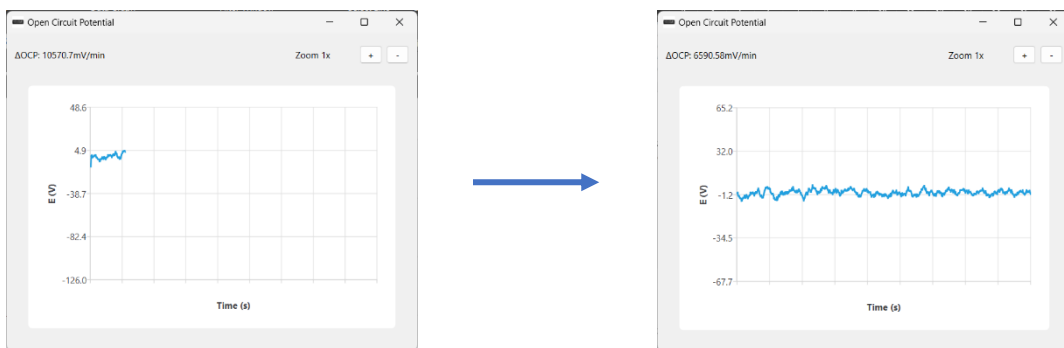

Passive OCP on 1 minute

Passive OCP on 10 minutes

Δ OCP can indicate the magnitude of the gap between the highest and lowest amplitudes. Δ OCP is evaluated as data per minute. It will take a minute to validate the correct value. To see the value difference better you can zoom in or zoom out on the graph by using + and – button. Passive OCP cannot be stopped unless you click the 'set' button in the OCP menu or disconnect the device by clicking the 'disconnect' button or deselect the current feature. You can zoom in and out on the graph using the '+' and '-' button located on the top right of the window. The zoom value will be displayed beside the buttons.

Axis Chart Options

Configure X and Y axis with several available options (B16). You can choose the minimum and maximum ranges to be displayed on the graph. You can add a custom linear line and remove it using this option. Line color and show/hide line and points can also be done using this option. The graph axis can be configured whether it is logarithmic or linear.

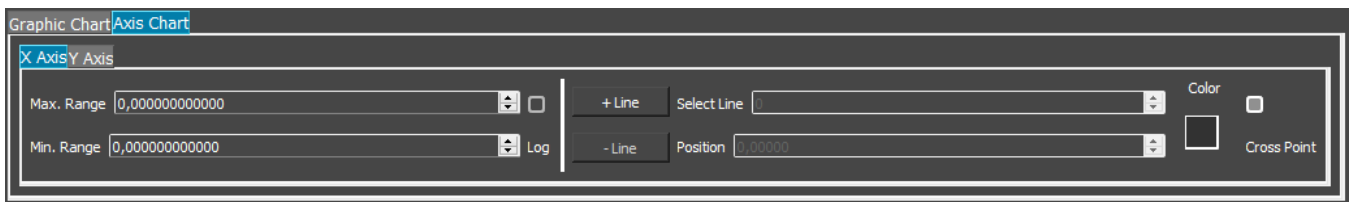

Help

Press to help button to open the html help window (B18). Alternatively, you can hover the cursor above objects inside the GUI such as buttons or labels to get more information about them.

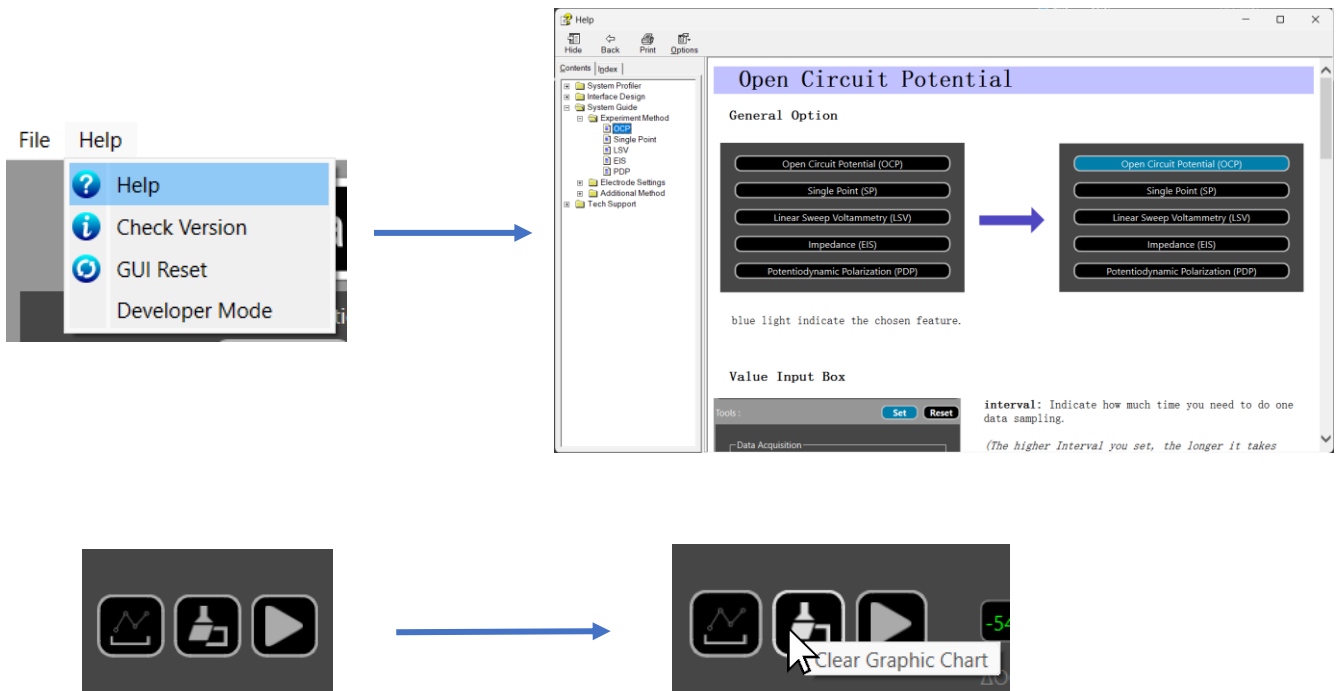

Check Version

To check the currently installed GUI version, simply click the “Check Version” button in the help options. This action will determine whether your GUI is up to date.

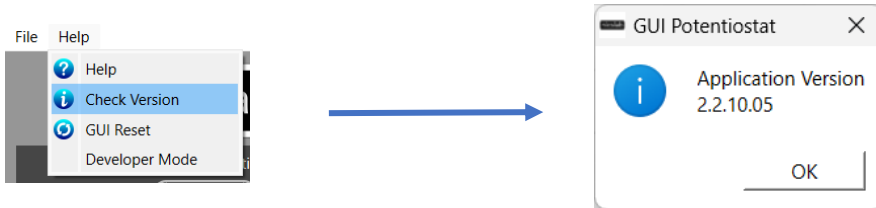

GUI Reset

In the event that the GUI stops working abruptly or if you encounter issues pressing buttons (such as save, set parameters, or run measurements), you have the option to reset the GUI by pressing the “GUI Reset” button in the help options. You can do reset or full reset. Reset action restores all parameters to their default state. Importantly, any measurements you have performed will remain intact within the GUI and can still be saved. Full reset action will clear all parameters, measurements, and plotted graphs.

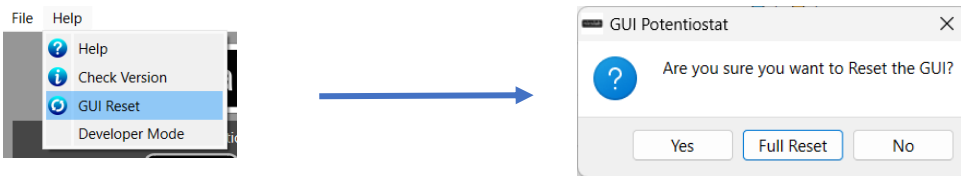

File Settings

Press to File button to open File Settings (B19). Here you can choose to Save a .csv file based on the graphic chart, or open a .csv file to plot it on the graphic chart. The CSV file (.csv) resulted from the Save function can be uploaded again through the Upload button. You may also create your own CSV file of voltage and current and upload it later.

- a) To save the graphic chart output, click File then Save as button on the top left menu.

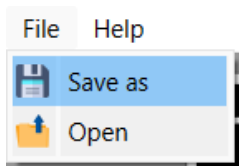

b) Select a directory and write the file name.

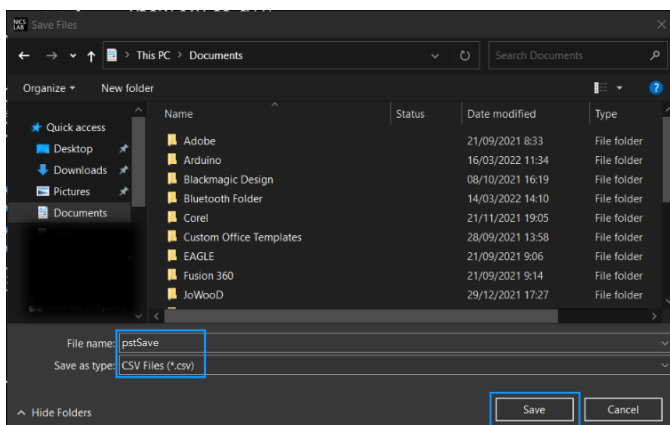

c) The file will be saved as a '.csv' file.

d) Check the (.csv) file that you have saved. The format will include the tools options that you set prior to the measurement. This is the example:

```
[Linear Sweep Voltammetry]

OCP Value :-0.410645 mV

Initial Voltage :-1400 mV|vs RE

Final Voltage :600 mV|vs RE

Interval :0.5 mV OR Frequency :2 Hz

Scan Rate :1000 mV/s

Voltage Range :±1 V

Current Range :±500 mA

[Output Data]

Timestamp,Voltage,Current,Current Unit
0.50000000,-1.44287109,-48.58398438,mA
1.00000000,-1.45751953,-48.82812500,mA
1.50000000,-1.44531250,-16.35742188,mA
2.00000000,-1.44042969,-94.97070312,mA
```

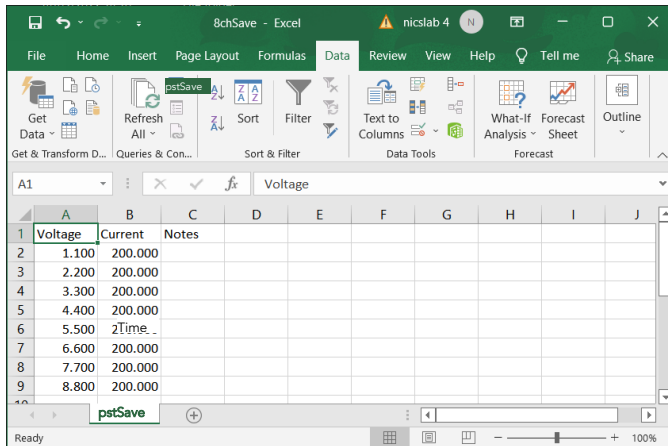

The voltage, current, and time are recorded. Except for EIS that will record the frequency, magnitude, phase, and power supply density. If the file doesn't appear to have saved data from all channel, consider trying to open the file with another program, like Notepad, for further inspection. For EIS, you can save raw data after saving the processed data. It will save the Sinusoidal Voltage and Current value and their corresponding frequency from start frequency to stop frequency in .csv.

e) To upload the configuration, click the 'Open' button.

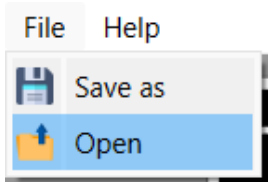

f) Choose and open the intended file.

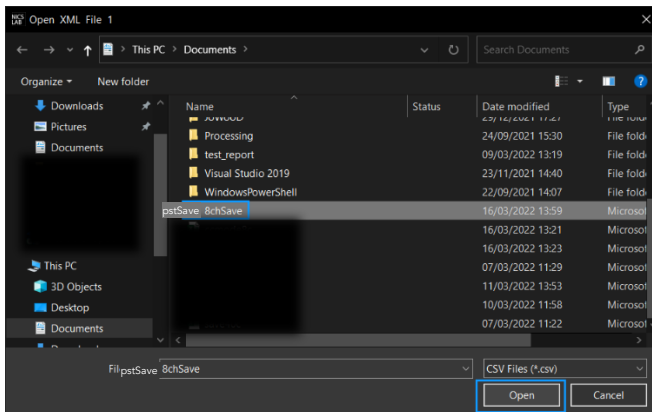

- g) Then, it will upload the configuration based on the configuration saved in the file. The settings data will be displayed on the tools section for each feature, and the data will be displayed as graph.

Tools : Set Reset

Initial Voltage
-300 mV vs OCP

Final Voltage
300 mV vs OCP

Scan Rate
1 mV/s

Data Acquisition

Interval
0.5 mV

Frequency
2 Hz

Voltage Range
±1 V

Current Range

Auto Range

Max ±1 A

Min ±1 mA

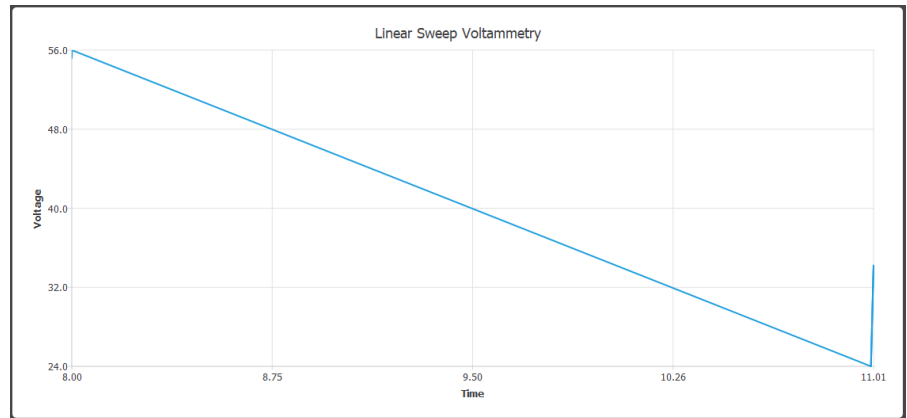

5. System Shutdown

This section describes how to shut down the XPOW-AX-PST.

In the case of using GUI, the steps are as follows:

1. Ensure that all graph plotting processes have been completed in the GUI, which means the left **Red** LED (A2, Figure 4) is turned off.
2. Press Disconnect Button in GUI (B1, Figure 9). The middle **Blue** LED (A2, Figure 4) will turns off.
3. Close the GUI application.
4. Press DC Power button on the front panel (A1, Figure 4).
5. Turn off the AC Power button on the back panel (A8, Figure 4).

NOTE: Once the shutdown occurred, the LED will be turned off. To use XPOW-AX-PST after a soft shutdown, just switch off and switch on again (restart) the XPOW-AX-PST.

6. Troubleshooting

Please use the following guidelines to identify a particular problem. If the solution does not rectify the problem, contact us at support@nicslab.com.

Table 5. Troubleshooting

| Problem | Cause | Solution |
|--|---------------------|--|
| Front end light off when switch turned on | AC Connection | Check AC connection to wall socket |
| Unable to upload the file | File format problem | Check the file format, it should be in .csv |
| No value after upload the file | File problem | Check the file content, make sure the content is in a correct format (check File Settings) |
| GUI crashed when uploading | | |
| Parameters is in wrong format after uploading | | |
| Connect message not showing after pressing connect | Connection problem | Turn off and on the hardware. If it is still not working, restart the GUI |
| When saving files, there is a "measurement ongoing" message even it is already finished | GUI problem | Do a GUI reset by pressing GUI Reset button in help options |
| Cannot close the GUI, there is a "measurement ongoing" message even it is already finished | | |

7. Warranty

Nicslab warrants the hardware and software designed by Nicslab to work accordingly, fulfilling the highest standard of quality product. Nicslab is not liable for consequential or incidental damages or for errors in subject to misuse, neglect, accident, modification, use in critical operation, or has been soldered or altered in any way outside stated by us or unauthorized maintenance.

Nicslab retains to change the material and technical data of this manual at any time without notice, in future editions.

Please do not hesitate to contact us at support@nicslab.com if you would like to have more information on warranty or return and refund policy.

8. Contact

California

Nicslab Ops, Inc.
228 Hamilton Avenue
3rd Floor, Palo Alto
Silicon Valley, CA 94301
United States
Phone: +1 (650) 521-9982
Email: support@nicslab.com
Website: www.nicslab.com

Indonesia

PT Nicslab Global Industri
Menara Asia Afrika, Jl. Asia Afrika No.133-137 LT. 9
Kb. Pisang, Kec. Sumur Bandung
Kota Bandung, Jawa Barat 40112
Indonesia
Phone: +62 22 8602 6854
Email: nicslab.id@nicslab.com

New York

Nicslab - Luminate
260 E. Main St., Suite 6408
Rochester, NY 14604
United States

Book a meeting [here](#).